

UNIFIED FACILITIES CRITERIA (UFC)

WATER SUPPLY: PUMPING STATIONS



APPROVED FOR PUBLIC RELEASE; DISTRIBUTION UNLIMITED

UNIFIED FACILITIES CRITERIA (UFC)

WATER SUPPLY: PUMPING STATIONS

Any copyrighted material included in this UFC is identified at its point of use. Use of the copyrighted material apart from this UFC must have the permission of the copyright holder.

U.S. ARMY CORPS OF ENGINEERS (Preparing Activity)

NAVAL FACILITIES ENGINEERING COMMAND

AIR FORCE CIVIL ENGINEER SUPPORT AGENCY

Record of Changes (changes are indicated by \1\ ... /1/)

Change No.	Date	Location

This UFC supersedes TM 5-813-9, dated October 1992. The format of this UFC does not conform to UFC 1-300-01; however, the format will be adjusted to conform at the next revision. The body of this UFC is the previous TM 5-813-9, dated October 1992.

FOREWORD

v\

The Unified Facilities Criteria (UFC) system is prescribed by MIL-STD 3007 and provides planning, design, construction, sustainment, restoration, and modernization criteria, and applies to the Military Departments, the Defense Agencies, and the DoD Field Activities in accordance with [USD\(AT&L\) Memorandum](#) dated 29 May 2002. UFC will be used for all DoD projects and work for other customers where appropriate. All construction outside of the United States is also governed by Status of forces Agreements (SOFA), Host Nation Funded Construction Agreements (HNFA), and in some instances, Bilateral Infrastructure Agreements (BIA.) Therefore, the acquisition team must ensure compliance with the more stringent of the UFC, the SOFA, the HNFA, and the BIA, as applicable.

UFC are living documents and will be periodically reviewed, updated, and made available to users as part of the Services' responsibility for providing technical criteria for military construction. Headquarters, U.S. Army Corps of Engineers (HQUSACE), Naval Facilities Engineering Command (NAVFAC), and Air Force Civil Engineer Support Agency (AFCEA) are responsible for administration of the UFC system. Defense agencies should contact the preparing service for document interpretation and improvements. Technical content of UFC is the responsibility of the cognizant DoD working group. Recommended changes with supporting rationale should be sent to the respective service proponent office by the following electronic form: [Criteria Change Request \(CCR\)](#). The form is also accessible from the Internet sites listed below.

UFC are effective upon issuance and are distributed only in electronic media from the following source:

- Whole Building Design Guide web site <http://dod.wbdg.org/>.

Hard copies of UFC printed from electronic media should be checked against the current electronic version prior to use to ensure that they are current.

AUTHORIZED BY:

DONALD L. BASHAM, P.E.
Chief, Engineering and Construction
U.S. Army Corps of Engineers

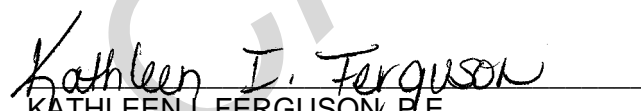
KATHLEEN I. FERGUSON, P.E.
The Deputy Civil Engineer
DCS/Installations & Logistics
Department of the Air Force

DR. JAMES W. WRIGHT, P.E.
Chief Engineer
Naval Facilities Engineering Command

Dr. GET W. MOY, P.E.
Director, Installations Requirements and
Management
Office of the Deputy Under Secretary of Defense
(Installations and Environment)

TECHNICAL MANUAL

WATER SUPPLY: PUMPING STATIONS

CANCELLED

APPROVED FOR PUBLIC RELEASE; DISTRIBUTION IS UNLIMITED

HEADQUARTERS, DEPARTMENT OF THE ARMY
OCTOBER 1992

WATER SUPPLY: PUMPING STATIONS

		Paragraph	Page
CHAPTER	1. GENERAL		
	Purpose	1-1	1-1
	Scope	1-2	1-1
	References	1-3	1-1
	Planning Factors	1-4	1-1
CHAPTER	2. DESIGN CONSIDERATION		
	General Design	2-1	2-1
	Demand	2-2	2-1
CHAPTER	3. PUMPING EQUIPMENT		
	Pumps	3-1	3-1
	Pump Drives	3-2	3-1
	Valving	3-3	3-5
	Flow Meters	3-4	3-5
	Piping Layouts	3-5	3-6
	Controls	3-6	3-7
	Reliability Factors	3-7	3-7
CHAPTER	4. HYDRAULICS		
	Headloss and System Curves	4-1	4-1
	Pump Cavitation	4-2	4-3
	Surge Analysis	4-3	4-3
CHAPTER	5. PUMPING STATION LAYOUTS		
	General	5-1	5-1
	Structural Systems	5-2	5-1
	Mechanical Equipment	5-3	5-1
	Electrical	5-4	5-2
	Building Environmental Systems	5-5	5-2
CHAPTER	6. OPERATING EFFICIENCIES		
	General	6-1	6-1
	Pump Operations	6-2	6-1
	Pump Scheduling	6-3	6-1
	Ease of Operation and Maintainability	6-4	6-1
APPENDIX	A. REFERENCES		A-1
	B. AVAILABLE MICRO COMPUTER PROGRAMS		B-1
	C. CASE STUDY FOR ADDING PUMPS TO AN EXISTING SYSTEM		C-1
	D. CASE STUDY FOR HYDRAULIC TRANSIENTS		D-1
BIBLIOGRAPHY			BIBLIOGRAPHY 1

List of Figures

FIGURE	3-1. Booster Pump Stations.	3-2
	3-2. Alternative Pump Applications.	3-3
	3-3. Pump Curves.	3-4
	4-1. System Head Curve.	4-1
	4-2. Two Constant Speed Pumps Operated in Parallel.	4-2
	4-3. Four Constant Speed Pumps of Equal Capacity.	4-3
	4-4. Checklist Surge and Water Hammer Analysis.	4-4
	4-5. Example Water Hammer Potential Calculation.	4-6
	5-1. Pump Station Typical Layout.	5-3
	5-2. Pump Station Sections.	5-4
	C-1. System Network for Hydraulic Analysis.	C-2
	C-2. Existing Distribution System-Maximum Daily Consumption.	C-3
	C-3. Improved Distribution System-Maximum Daily Consumption.	C-4
	D-1. Uncontrolled Surge.	D-1
	D-2. With Air Vessel.	D-2
	D-3. With Pressure Relief Valve.	D-3

CHAPTER 1

GENERAL

1-1. Purpose. This manual provides guidance and criteria for the design of high lift and water booster pumping stations in potable water distribution systems.

1-2. Scope. Criteria is provided for pumping units operating as components in distribution systems. Guidance is provided for sizing and selection of pumps and pump drives, piping, control valving, flow metering, pump station structures, and operational features.

1-3. References. Appendix A contains a list of references used in this document.

1-4. Planning Factors. Main pumping stations which supply water to the distribution system will be located near the water treatment facility or a potable water storage facility and will pump directly into the piping system. These pump stations may be a part of these other structures. Pumps which pump directly into transmission lines, and distribution systems are sometimes called high lift pumps. Booster pumps may be located anywhere in the system to increase the pressure in the pipeline. Booster pump stations are usually located remote from the main pump station, as in hilly topography,

where pressure zones are required. Booster pumps may be needed to handle peak flows in a distribution system which can otherwise handle the normal flow requirements. Where a pump station is added to an existing installation, previous planning and design, which is based upon a total system hydraulic analysis should be consulted before the addition is designed. New or updated studies will determine station location and present and future demand requirements. Locating permanent pumps so that there will be a positive head on pump suction will eliminate many operational problems. Site selection will be determined from evaluation of a topographic survey and flood plain analysis to determine if there are any flooding probabilities of the proposed plant site. The site must not be subject to flooding. Major planning factors are: availability of electric power, roadway access for maintenance and operation purposes, security, and adverse impact, if any, upon surrounding occupancies. Site development will depend upon a site soils analysis showing adequate support for foundations or possible ground water problems, and a grading and drainage plan of the area showing that runoff away from the structures can be obtained.

CHAPTER 2

DESIGN CONSIDERATION

2-1. General Design. The sizing of each component in the distribution system will depend upon the effective combination of the major system elements: supply source, storage, pumping, and distribution piping. The hydraulic analysis of the total distribution system is discussed in TM 5-813-5. Water storage is discussed in TM 5-813-4.

2-2. Demand.

a. General. Population and water consumption estimates are the basis for determining the flow demand of a water supply and distribution system. Flow and pressure demands at any point of the system are determined by hydraulic network analysis of the supply, storage, pumping, and distribution system as a whole. Supply point locations such as wells and storage reservoirs are normally known based on a given source of supply or available space for a storage facility. Criteria for determining water demands are discussed in TM 5-813-1 and TM 5-813-7.

b. Factors for Determining Demands. The hydraulic network analysis should assume the following demand rates:

- (1) Annual Average Daily Consumption (ADC)
- (2) Annual Maximum Daily Consumption (MDC)

- (3) Peak Hour Consumption on Annual Maximum Day (MDC/Peak-Hour)

- (4) MDC plus Simulated Fireflow

Several analyses should be made to investigate alternative piping arrangements within the distribution system as well as for connecting proposed pumping stations to the distribution system. If future improvements are contemplated, the analysis should be performed based on future conditions, thus assuring the correct selection of the final alternative to be implemented initially.

c. System Pressures. The pressure distribution in the system will assume the following criteria:

- (1) Maximum curb pressures (70 psi)

- (2) Minimum curb pressures at any point on the network (usually 30 psi)

- (3) Residual curb pressure to be maintained at a point of simulated fireflow (20 psi minimum) For large distribution system design a pressure contour map will be developed using known topography and the hydraulic network analysis and showing pressure in pounds per square inch. Pressure contours must be adjusted for elevations of surrounding terrain. The pump discharge head will be derived from the system pressures at the pump station location plus the pump station piping head loss.

CHAPTER 3

PUMPING EQUIPMENT

3-1. Pumps.

a. General. The location of the pump station and intake structure, and the anticipated heads and capacities are the major factors in the selection of pumps. The function of a pump station in the overall distribution system operation can also affect the determination of capacities. Basic pump hydraulic terms and formulas, pump fundamentals and applications, and instructions for installation, operation and maintenance are given in the Hydraulic Institute Engineering Data Book and Hydraulic Institute Standards. It is recommended that these books be part of the permanent library of the fluid system designer.

b. Pump types. There are generally two types of pumps used for potable water pumping applications—the vertical turbine pump, line shaft and submersible types, and the centrifugal horizontal or vertical split case pump designed for water-works service. If the pump station and intake structure are to be located within a surface or underground reservoir, vertical turbine pumps with the column extending down into the reservoir or its suction well will be a logical choice. If the pump station is located at an above ground storage facility, split case centrifugal pumps will be the preferred selection. These pumps are normally horizontal but vertical split case pumps are common where there is limited space. Flexible couplings will connect pump and driver shafts. Split case pump design is used for ease of maintenance of the rotating elements, which can be removed without disconnecting the suction or discharge piping. For standard waterworks design for potable systems, pump casing will be cast iron and impellers will be bronze. Base for pump and driver will be cast iron or fabricated steel. Pump impeller and casing may have wearing rings depending upon manufacturers' recommendations and consideration of the cost of replacing the rings. Pumps will have mechanical seals or packing seals, ball or roller bearings, and lubrication system. Pumps which may operate under extreme conditions such as at the ends of pump curves or under frequent on-off operation will have packing seals in lieu of mechanical seals. Mechanical seals will be considered for pumps likely to stand idle for long periods of time. Where scale or abrasive water conditions exist, pump linings and other material options for impeller, shaft, wear rings, and seals are available. A water analysis at the point of service must be secured and analyzed before non-standard materials

are selected. Lubrication for horizontal pumps will be oil bath or grease. Vertical dry pit pumps will be grease lubricated. Vertical wet pit pumps will have oil or water lubrication.

c. Pump applications.

(1) *Booster pumps.* Booster pump may be above-ground or underground. Figure 3-1 illustrates schematic piping of two types. Pump and controls selection for in-line booster pumps will consider minimum suction pressure, and automatic discharge cut-off pressure. For small booster pump applications, as for remote housing or satellite military facilities with peak water demands of less than approximately 1500 gpm the designer should consider a pre-assembled skid mounted package unit including all of its hydrostatic, flow, instrument and electrical components.

(2) *High lift pumps.* Figure 3-2 shows examples of pumps supplying the distribution system.

d. Pump curves. With the system head curve defined, it is possible to select a pump to deliver the required capacity. Manufacturer's published pump head-capacity curves for the selected type of pump will be used for this purpose. Since these pump curves usually apply to a particular impeller and pump design, different manufacturers may show slightly different performance for the same type and size of pump. Therefore, several manufacturers' pump curves should be checked to establish a realistic and cost effective criteria for the pump selection. Figure 3-3 shows three types of pump head capacity (performance) curves; a "normal rising" curve, a "drooping" curve and a "steeply rising" curve.

For pumps in a typical water supply and distribution system, only pumps with "normal rising" to "steeply rising" performance curves should be used. Pumps with these characteristics will perform well in parallel operation and will have relatively small capacity change with pressure changes. In addition, the brake-horse power curve will be relatively flat, which will minimize the risk of overloading the motor particularly in applications in direct pressure systems with possible high pressure fluctuations.

3-2. Pump Drives. Pump drives for water supply and distribution pumps will be electric motors. Diesel or other fuels will be considered as a power source only for emergency use. The drivers will be constant speed AC motors of the squirrel-cage-

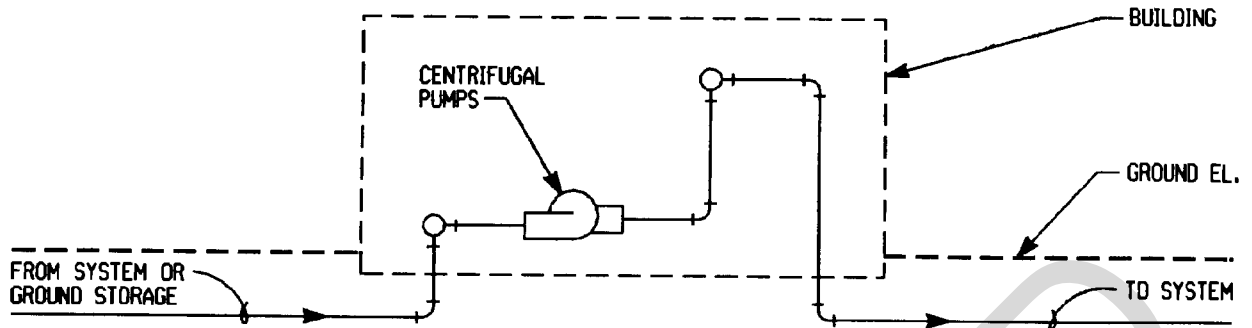

BOOSTER PUMP STATION
(SECTION)

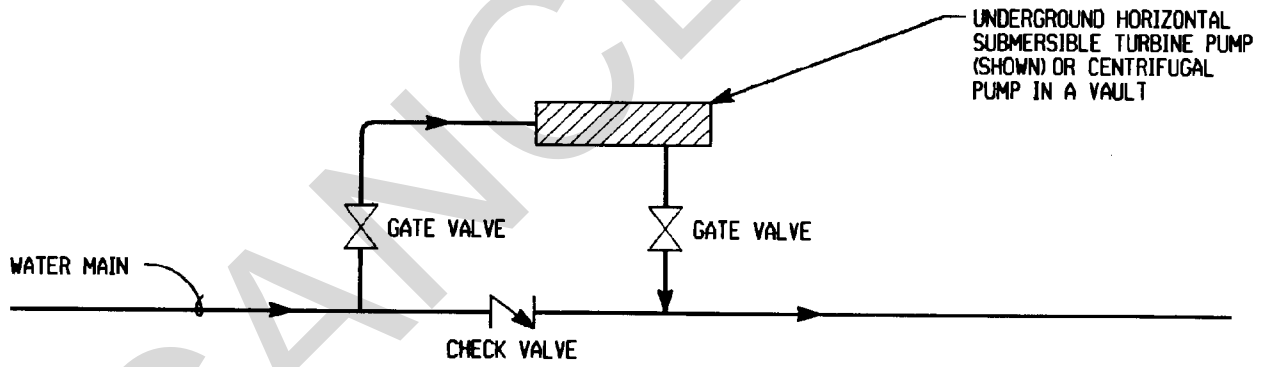

IN-LINE BOOSTER PUMP
(PLAN)

Figure 3-1. Booster Pump Stations

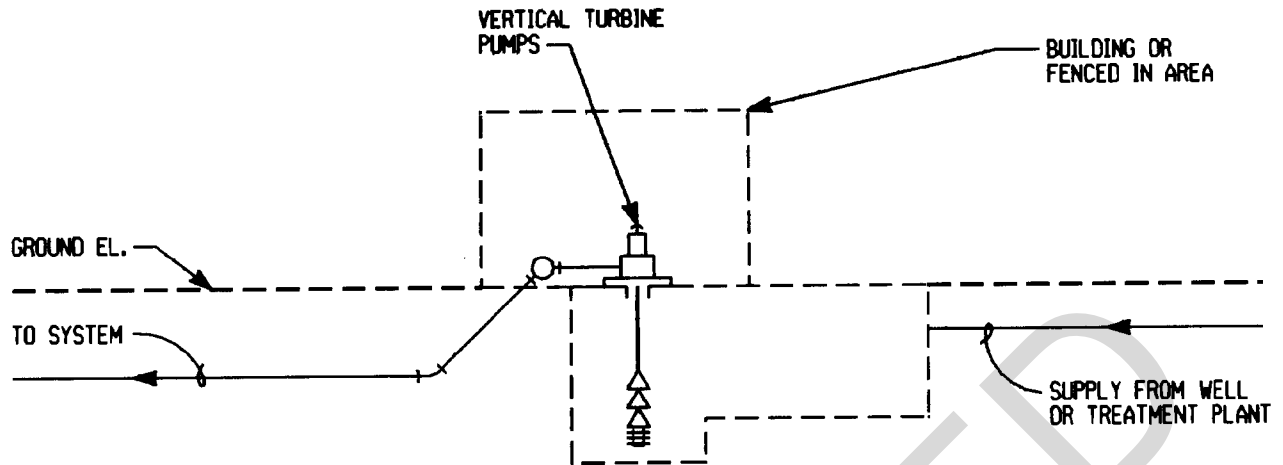

UNDERGROUND RESERVOIR AND PUMP STATION
(SECTION)

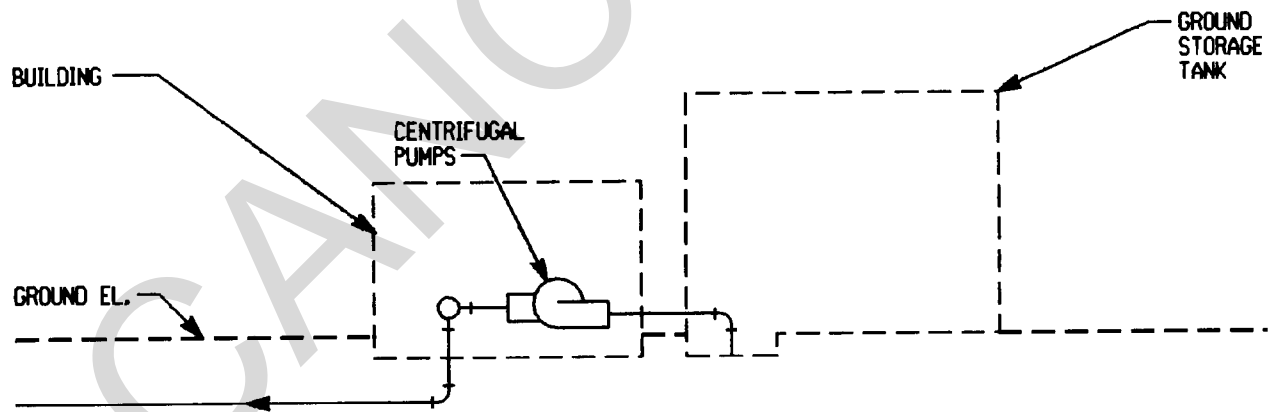

GROUND STORAGE TANK AND PUMP STATION
(SECTION)

Figure 3-2. Alternative Pump Applications

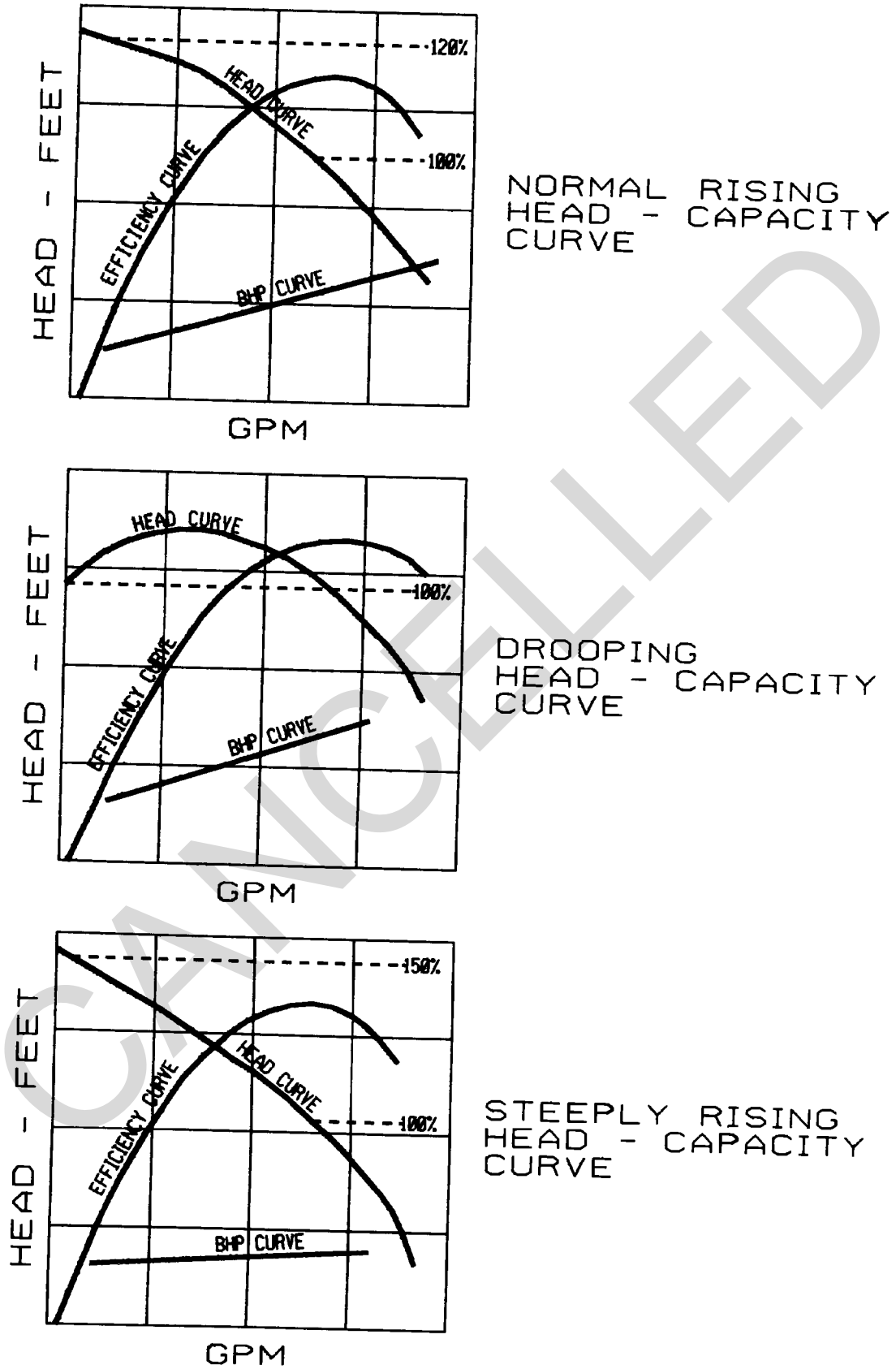

Figure 3-3. Pump Curves.

induction, wound rotor or synchronous type. Drives for fire pumps will be in accordance with NFPA 20.

a. Variable speed drives. Variable-speed devices will be considered only for larger pumps and only if justified by an accurate economic analysis. There are many variable speed control systems available. Although the principle may vary, these systems consist of four basic elements: sensor, controller, programmer and variable speed driver. A general recommendation on the type of system for specific pumping applications cannot be made because of differences of available systems. If system requirements, pump capabilities, and overall economics favor consideration of variable speed pump operation, the designer should consult the pump manufacturers and their recommended variable speed representatives to determine the best method of pump control, and to obtain a cost analysis of variable speed versus constant speed for the specific application. Normally the addition of one or more smaller modulating pumps in parallel with the other pumps will be selected to handle any demand for varying pumping rates.

b. Motors. Motors will be selected with sufficient capacity to drive the pumps under service required without exceeding 85 percent of the specified rating. Motors will be in accordance with NEMA MG1. Refer to Hydraulic Institute Standards for discussions on types of electric motors.

3-3. Valving. Valves used in pump station piping system will include: gate valves, globe and angle valves, cone valves, butterfly valves, ball valves, check valves, and relief valves. Globe, ball, cone, and butterfly valves will be best suited as control valves for modulating the flow to provide desired pressure or flow rate. Check valves will not be used in vertical piping.

a. Suction piping valves. A gate valve will be installed in the suction piping so that the pump can be isolated from the line. The stem of this valve may be installed horizontal to avoid air pockets. Butterfly valves will not be installed in pump suction piping.

b. Discharge piping valves. A check valve and a gate or butterfly valve will be installed in the discharge piping with the check valve between the pump and the gate valve. The check valve will protect the pump from excessive back pressure and prevent liquid from running backwards through the pump in case of power failure. The gate valve will be used to isolate the pump and check valve for maintenance purposes. In installations where an automatic surge control valve is needed the check valve will be eliminated provided the drive will not be a wound rotor motor and pump design will

allow some reverse rotation. Pressure relief valves, commonly diaphragm activated globe or angle type, will be installed in discharge piping system for flow control and/or pressure regulation, and to protect pump equipment and piping system from excessive surge pressures which could exceed the ratings of system components.

c. Air release and vacuum relief. Air release and vacuum relief valves will be used on discharge piping for vertical turbine pumps.

d. Control system valving. Pump control systems range from single hand-operated valves to highly advanced, automatic flow control or pump speed control systems. Particularly, in an unattended high head pump station the control valve may have a controller to close automatically when the pump is stopped and to open once the pump has reached specified speed after the pump is started. Control valves are installed to prevent surge pressures, which otherwise cause water hammer and high pressures. A good surge control valve with low head loss will consist of a hydraulically operated valve on the pump discharge complete with speed control device to permit independent timing of both the valve opening and closing speeds. The controller will include hydraulic and safety equipment wired to function in sequence with the pump motor starting gear.

(1) *Hydraulic accumulator system.* A properly selected hydraulic accumulator system can operate on clean water, oil and other fluids. The water system may allow formation of algae, scale and create corrosion in the controls and cylinders and must be constantly checked. Hydraulic oil specially selected for this application provides the best and most trouble free qualities.

(2) *Other control valve systems.* Control valves design and versatility are constantly improving. The selection of a control valve for a specific installation should be made only after consultation with the manufacturers.

3-4. Flow Meters.

a. General. Pump station water is metered for several reasons: to calculate distribution system losses by subtracting the total of meter readings from total supply, to monitoring pump efficiency, and to determine gross billings for water supplied. High rate of accuracy and wide range criteria will be desirable in most pump station flow meter applications. Because of constant improvements in old technologies and because new technological developments continuously provide the market with new products, the designer must review the state of the art before making final meter selection.

b. Design criteria.

- (1) *Accuracy.* + 1% of rate
- (2) *Rangeability.* To cover complete design range
- (3) *Maintainability.* Routine by user. Major overhaul by readily available factory service
- (4) *Initial cost.* Minimal
- (5) *Operating cost.* Minimal
- (6) *Design life.* 20 years minimum

c. *Meter selection.* The two most common flow meters in water pumping installations identified in the order that they best comply with the design criteria are as follows:

(1) *Ultrasonic meter.* Ultrasonic meter for clean liquids using "transit time" technology will meet all the set criteria. Straight approach length equivalent to 10 pipe diameters is important. No maintenance is required.

(2) *Current meters.* Current type meters used for pump station discharge and mainline measurements include turbine and propeller meters. Accuracy of these meters are +2% instead of +1% over an approximate rangeability of 10:1. These meters require a length equivalent to 5 pipe diameters straight approach and periodic maintenance. Turbine meter standards for sizes 1 1-1/2 inch through 12 inches are covered in AWWA C 701 and propeller meter standards for sizes 2 inches to 36 inches in AWWA C 704.

(3) *Selection features.* Additional advantages of the ultrasonic meter include non-contact with liquid, versatile design regarding data monitoring and clamp-on transducer for any size pipe over 1 inch in diameter. The meter is most cost effective for larger pipe applications. This type of meter does not require any pipe by-pass arrangement with shut-off valves. The advantages of current meters are lower initial cost for small size meters, simplicity in design, and historically a proven product over many years.

(4) *Flow recorders.* Flow recorders may supplement the flow meter device to record pump performance, condition of pump, and energy usages rates. For complex installations, flow recorders may be part of a remotely located controller or part of remote stations which monitor other data such as speed indication, vibration monitoring, and bearing or casing temperature indicators. Flow recorders will be used to indicate flow fluctuations over the course of a day. Technological advances have made transducer output measurement possible with self-balancing recorders and computer-compatible data-gathering systems. Limits on accuracy, distance of signal transmission, and speed of response will determine data transmission methods. Mechanical signals from a metering device can be converted to electrical form and vice versa, but may be limited by

active physical links and inertial effects. Transmission of data from a transducer to a recording system may be accomplished by a pair of wires. Radio telemetry techniques may be useful where attaching wires are impractical. Readouts may be in analog form in strip and dial chart recorders, and analog signals on tape. In digital recording, conversion of signals to numerical values may be by electromechanical or one of a variety of electronic systems. The latest state-of-the-art techniques will be reviewed with measurement and instrument manufacturers when selecting recording and transmission equipment.

3-5. Piping Layouts.

a. *Suction piping.* Proper design of suction piping is important to minimize pressure losses and allow sufficient flow into the pump. Many net positive suction head (NPSH) problems will be eliminated by proper suction piping design. Suction piping must be kept free of air leaks. Pipe joints will be screwed or flanged joints for smaller sizes and flanged for larger sizes.

(1) *Suction pipe sizing.* Suction piping should be as short as possible but never smaller than pump suction opening. If a longer suction pipe is required, it should be one or two sizes larger than the pump suction opening depending on the length. Suction piping of same size as pump suction nozzle for a double suction pump will have a minimum of 10 pipe diameters straight run from the suction flange of the pump. The pump manufacturer of the selected pump will be consulted regarding special piping arrangement for vertically mounted pumps or for other space limitations. Suction pipe headers in multiple pump installations will have headers sized so that each pump receives its proportional flow amount.

(2) *Suction elbows.* To avoid high unequalized thrust loads that will overheat bearings and cause undue wear as well as affecting hydraulic performance, suction elbows for double suction pumps will be positioned in a vertical position only to allow the liquid to enter evenly on both sides of the impeller. Long radius elbows will be used.

(3) *Pipe slope.* Suction pipe will slope upward to the pump connection when operating on suction lift. When reducing the piping to the suction opening of the pump and where operating on suction lift, an eccentric reducer with the eccentric side down will be used to avoid air pockets.

b. *Discharge piping.* If the discharge pipe is short, the diameter of the pipe will be same as pump discharge nozzle. If the discharge pipe is long, the diameter will be increased by one or two sizes depending on length.

c. Meter runs. At meter locations the required straight approach and downstream length of straight pipe must be considered. It is good practice to allow straight runs of 10 and 5 pipe diameters for upstream (approach) and downstream of meters in the piping layout. This will accommodate any type of meter.

3-6. Controls.

a. *Description.* Pump controls will have the capability to provide the desired flow rates, pressures and liquid levels; to provide protection from pump and piping system damage; and to serve as a tool to find system problems which may need operational adjustment, repair or maintenance. Control systems consist of the following:

- (1) Sensing and measuring elements (primary device).
- (2) Comparison and relaying element (controller).
- (3) Final control element (as a valve) to produce the required change including an actuator to move the control element.

b. *Pump control systems are divided into on-off and modular.* The successful operation of the control system depends on several factors as follows:

- (1) An accurate definition of the control job to be done.
- (2) A review and evaluation of available devices/systems suited to do this specific job.
- (3) Selection of device and system design in cooperation with the manufacturer of the selected equipment.

c. *Sensing and measuring elements.* Automatic pump control and valve operation sensing and measuring elements will detect values of changes in liquid level pressure or flow rate and emit a signal which may be amplified and/or converted into another medium in a transducer as rotary motion or air pressure to electric voltage. The most common primary devices used in waterworks are liquid level sensors, pressure sensors and flow meters.

d. *Comparison and relaying element.* The variable that is most convenient or advantageous to measure is rarely the one best suited for direct use in the control system or for actuation of the final control element. Conversion of sensed or measured variable values into another signal medium is therefore necessary. The comparison and relaying means, the transducers and transmitters, are usually housed together in the controller which often is physically separated from the primary device.

e. *Final control element.* For the final control element, valves and pumps serve for on-off control and modulating needs in water pumping systems. A

control valve is a valve that modulates the flow through it to provide the desired downstream or upstream pressure or flow rate. Although almost all valves can be partly closed and control flow to some degree, the term "control valve" means a specialized type of power-activated valve designed to modulate flow to meet system demands or for surge protection. The term "pump" as a final control element is a pump provided with automatic variable speed control drive to maintain an essentially fixed flow rate and for controlled flow rate increase/decrease at start/stop of pump to minimize surges in the system. Because of unique features available from control equipment manufacturers, the designer should contact the manufacturers before selecting valve and pump control equipment.

f. *Instrumentation.* Instrumentation for a water pumping station will supervise and monitor the routine operation of pumps, their drives and accessories to sustain a desired level of performance and reliability. Alarm situations will be identified, such as low delivery flow and low pressure, pump failure, power failure, and low suction head (water loss). Alarm situations will include engine drives as required to support the system reliability factors. The type and extent of supervisory instrumentation for the installation will be determined from:

- (1) Pump application in terms of what effect the pump will have on the system if it failed to perform its function.
- (2) Pump design, type, size and parameters that could affect reliability and hydraulic performance such as variable speed pumps and long shaft high speed pumps, which may need monitoring of vibration, bearing and hydraulic performance.
- (3) Operator experience with similar pumps may indicate a need for applying supervisory instrumentation.
- (4) Installations with operators in attendance will need minimum monitoring while unattended pump stations in remote location will require substantial monitoring of measurements and alarms.

3-7. Reliability Factors.

a. *General.* A pumping station usually represents one of the major and most costly components of a water distribution system, therefore pump station reliability will be considered. The number of pumps will depend upon present and future needs. An economic analysis should be performed to determine the number of pumps to be installed. In smaller stations a single pump may be most economical to meet the peak demand. Whenever a single pump is sufficient, two equal size pumps,

each able to handle the peak demand, must be provided and set-up to alternate. Whenever two or more pumps are cost-effective to meet the peak demand, additional pump capacity or pumps must be installed so that peak demand can be met with the largest pump out of service. All pumps should alternate. Raw water pumping stations must have a minimum of three pumps. To prevent large pumps from repeatedly cycling on and off during periods of low demand, one small modulating pump, commonly known as a jockey pump, shall be installed.

b. Emergency power. During curtailed power or brown-out, emergency power is usually provided by a diesel generator although other standby fuels such as gasoline and natural gas may be used if available and economical. Diesel engines and diesel engine fueling systems are preferred as more reliable. Emergency power will not be provided for standby equipment. Emergency power will be limited to average demand conditions for water distribution and transmission systems and to 50 percent of the treatment plant's capacity for raw water supply stations.

c. Factors. The reliability of the pumping station as a whole and of its individual components must be determined. Some typical factors and components which may be included in a reliability

and availability evaluation are listed as follows —

- (1) water demand and emergency storage
- (2) preventative maintenance
- (3) wear/life expectancy of subcomponent
- (4) repair
- (5) power transmission
- (6) parallel operation and stand-by equipment
- (7) emergency power
- (8) surge protection
- (9) pumps
- (10) valves
- (11) piping
- (12) motors
- (13) controls
- (14) time factors

Reliability evaluation should be part of the planning and design process to make certain that a reliable and cost effective design alternative will be implemented. Two independent power supplies might be considered for the most critical main pumping stations. Existing power supplies will be investigated to determine historically the number of power outages and length of outages occurring over a pumping period. Where direct connection of an engine drive to a pump is considered, a cost analysis will be made comparing engine generated electric power versus direct engine connection.

CANCELLED

CHAPTER 4

HYDRAULICS

4-1. Headloss and System Curves

a. General. The location and required capacity of a potable water pumping installation will be determined from a hydraulic network analysis of the distribution system. Pumping requirements for various design conditions at one or several locations can be simulated for varying flow rates over extended periods of time by use of computer programs. Refer to appendix B for available computer programs. Based on this information, the pump station including suction and discharge piping systems will be designed. To make an accurate determination of the head requirements, a system head curve must be derived depicting calculated losses through the system for various pumping rates. A schematic should be drawn showing configuration and size of all piping including valves and fittings. Information on system headloss calculations can be found in TM 5-813-5. Pumps at the pump stations will be sized to handle individually and in combination the maximum projected daily consumption, the peak hourly rate plus fire load demand, and the estimated minimum hourly rate at some future date. Refer to appendix C for a case study for adding pumps to an existing distribution

system. The pump discharge head will be the required pressure needed at the point of connection to the distribution system plus the pumping station and pump discharge and suction piping head loss. Example problems and information on friction loss in suction and discharge piping will be found in the Hydraulic Institute Engineering Data Book. A design analysis will be prepared to show head loss and friction calculations for present and future demands.

b. System head curves. In every case where liquid is transported from a point A to a point B, there is a friction loss through the piping system between the two points, and there may be an elevation or pressure differential. A simplified system head curve is shown in figure 4-1.

After analyzing the actual system to determine its requirements, it is good practice to plot the system head curve for any flow rate from 0 to beyond the pump station required peak capacity knowing that the friction loss will be 0 at 0 gpm flow.

c. Pump selections. With the system defined, pumps will be selected. The point of intersection between the pump performance curve and the system head curve represents the capacity at which

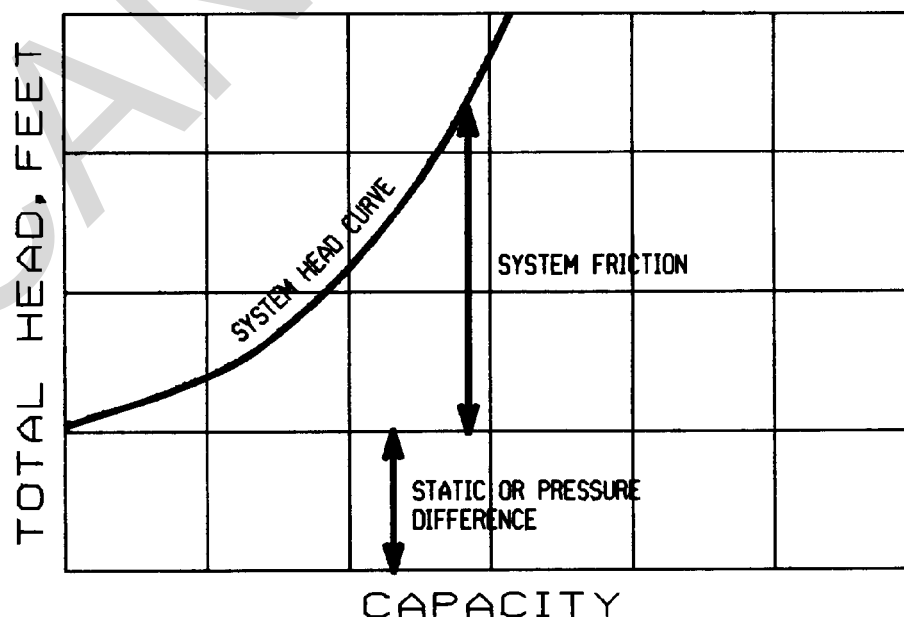

Figure 4-1. System Head Curve.

the pump will operate. Whenever possible, it is always advisable to select and operate pumps so that they will normally operate in a region of reasonable capacities; that is, not too far to the left or to the right of their best efficiency point. These operating limits should be well within the recommended operating limits set by the manufacturer. A pumping installation will often have fluctuating pressure differential depending on distribution system demand and pressure conditions or on water level in a storage tank. In this case, the system curve moves up or down as the pumping cycle progresses and the pump selection becomes more critical. It is important to select the pumps so that they will operate within safe operating limits near the best efficiency point for both the high and the low system head conditions. For small pumps, when net positive suction head (NPSH) is critical, minimum flow limitations of about 25% of capacity at the best efficiency point should be imposed. Large high horsepower pumps have minimum flow limitations as high as 70% of the capacity at the best efficiency point.

d. Parallel operation. In parallel operation two or more pumps discharge into a common header. Usually, pumps operating in parallel will have the

same cut-off head. In a station with three constant speed pumps, with the larger pump out of service, the two smaller pumps will operate with pump curves illustrated in figure 4-2. According to the reliability factor these two pumps running together in a three pump station must handle 100 percent of peak flow. Each pump alone will pump 60% of this flow. Figure 4-3 shows a possible arrangement for a large station. Peak flow is handled by four constant speed pumps in parallel. As the pressure increases pumps can be deenergized one at a time so that the entire range of expected demands can be covered in such a manner that each pump is always operating at a capacity near its best efficiency point. The illustration shown is not the best pump selection for this system since the increase in capacity gained when going from a three to a four pump operation is negligible. The fourth pump adds little to the total discharge capacity. For this system a better arrangement would be to increase the pump capacities slightly and use a three pump system. In any case, the reliability factor will dictate that peak demand will be met with the largest pump out of service. This illustrates the need to compare carefully the characteristics of the pump and the system head curve.

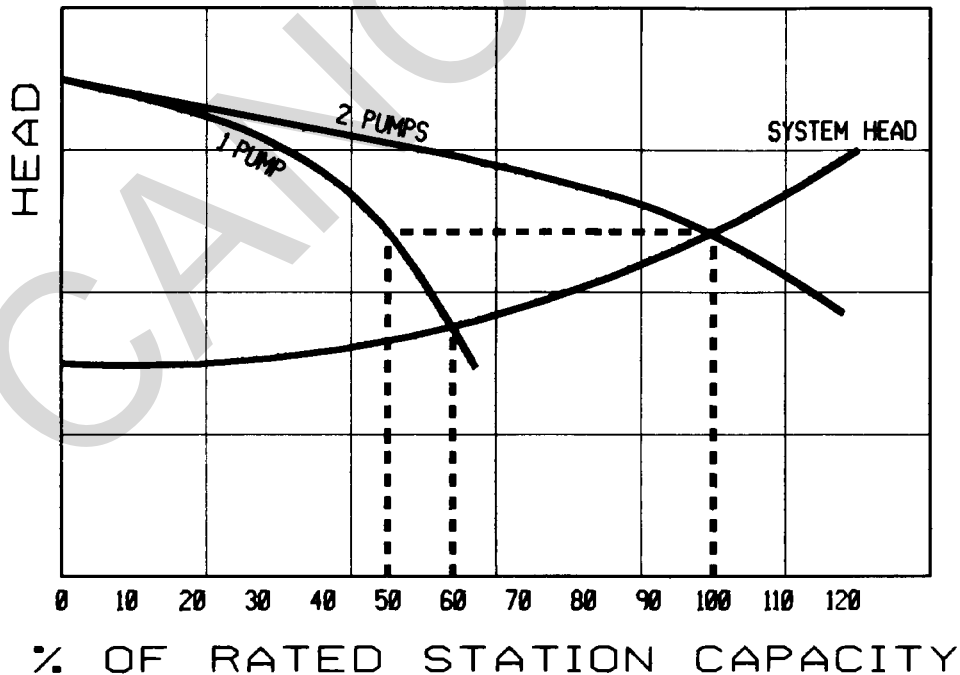

Figure 4-2. Two Constant Speed Pumps Operated in Parallel.

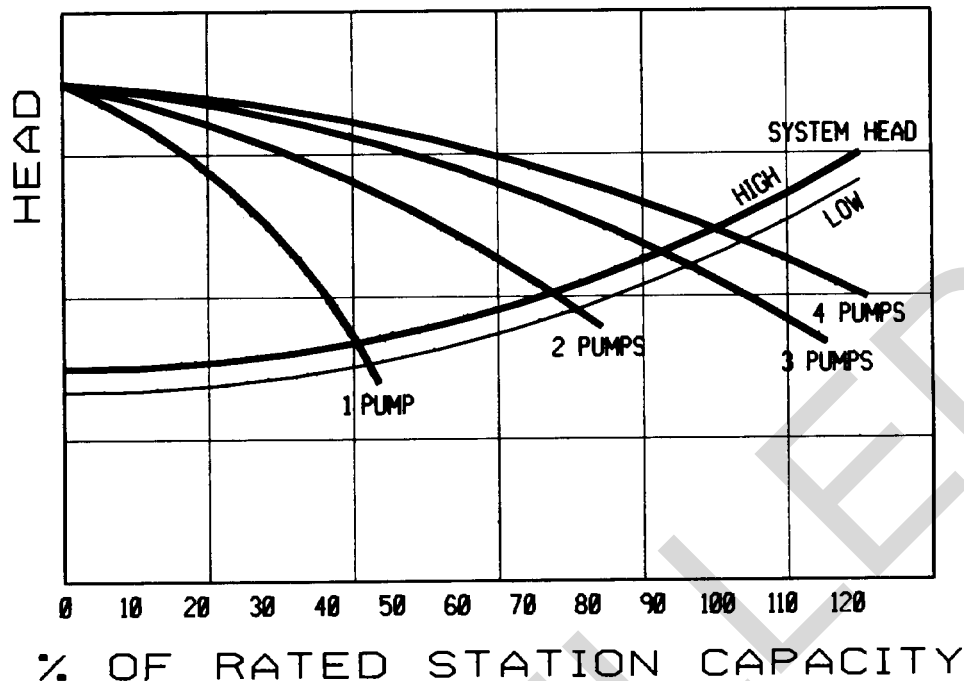

Figure 4-3. Four Constant Speed Pumps of Equal Capacity.

4-2. Pump Cavitation.

a. Cavitation is a term used to describe a phenomenon that may occur in a pumping installation and may occur in piping systems because of liquid velocity changes. Cavitation in centrifugal pumps is explained in TM 5-813-5. Cavitation in pipe lines may take place at sudden enlargements of the pipe cross section, at sharp bends, throttled valves or similar situations. The designer should avoid the following conditions for centrifugal pumps:

- (1) Operating heads much lower than rated head at peak efficiency of the pump.
- (2) Operating capacities much higher than rated capacity at peak efficiency of the pump.
- (3) Suction lift higher or positive suction head lower than recommended by the manufacturer.
- (4) Liquid temperatures higher than that for which the system was originally designed.
- (5) Pump speeds higher than manufacturer's recommendations.

b. For propeller pumps, the designer should avoid these conditions except conditions (1) and (2) will be stated as follows:

- (1) Operating heads much higher than peak efficiency of the pump.
- (2) Operating capacities much lower than capacity at peak efficiency of the pump. Cavitation

will not be a problem in a pump installation if the system is designed, selected, installed, and operated in accordance with the recommendations of the designer and the manufacturer.

4-3. Surge Analysis

a. *General.* Surges in pipelines carrying liquids are usually caused by opening, closing or regulating valves or pumps starting and stopping. These surges, also called hydraulic transients may range in importance from a slight pressure or velocity change to sufficiently high pressure or vacuum to rupture the piping system, to damage pumping equipment and cause extensive shutdown time. Water hammer, a result of hydraulic transients, will occur when the total surge pressure exceeds approximately twice the value of the static pressure in the system when the fluid is at rest. "Water hammer" is discussed in TM 5-813-5. Surge protection analysis will be performed on critical sections of the piping system to verify design and surge control equipment selection. If excess transient pressures are predicted by the analysis, design and mechanical equipment application will be modified. Hydraulic surge control is a specialized field. If a detailed surge protection study is required, it should be provided by engineers or consulting engineering firms specialized in this field. Detailed pipeline surge analysis by an

expert should be considered under the following design conditions:

(1) Generally, if the interaction of pump station, piping system, valves and control system is complex following a power failure or during startup conditions.

(2) If power failure at the pump station would result in significant reverse flow, which can slam check valves or cause a fluid rejoinder surge. In a system with a flat pipeline profile, reverse flow surges are usually not significant. In a system where the pumps work against a significant static lift, surge pressures can be many times the maximum steady state operating pressure.

(3) If the pipeline profile has significant intermediate high points where the fluid may separate, following power failure, and result in high surge pressures upon rejoining.

(4) If the pump station or individual pump take suction through a pipeline of significant length (several hundred feet) a power failure may result in high pressure heads. For pumps located immediately adjacent to storage tanks, suction line pressure transients are usually insignificant.

(5) If the pump station is equipped with discharge check valves and air vessels, the check valves may be slammed shut by the air vessel or parallel connected pumps following power failure.

(6) If the preliminary hand calculations indicate that surge control equipment is required in the system, optimum performance and surge control equipment selection could be established through detailed surge analysis. As a general rule; surge analysis should be performed for vertical turbine pump installations and any pump installation where individual pump capacity exceeds 500 gpm. A typical checklist of information required for a detailed surge and water hammer analysis is shown in figure 4-4. The example in figure 4-5 shows the total surge head exceeding the allowable surge head

for a pipeline.

(7) Specialized computer programs for hydraulic transient analysis are listed in Appendix B. A case study for control for hydraulic transients created due to power failure and when using air-vacuum valves is included in Appendix D.

b. Surge control methods. The most common devices to overcome the effects of excessive hydraulic surge pressures in water pumping systems include —

(1) Spring or weight-loaded check valves, which are designed to close before the hydraulic pressure wave reverses. This device may protect the pump but will not eliminate the water hammer in the rest of the system.

(2) Surge relief valves, which will open at a preset surge pressure but do not prevent the occurrence of the water hammer. They are frequently used as a back-up for other control methods. Several manifold mounted relief valves will be considered in lieu of one large relief valve to minimize water wastage.

(3) Air cushioned surge tanks, which will absorb pressure increases in stopping and starting pumps. If properly designed they will reduce pressures to protect the system. Space requirements and costs have limited their usage in water pumping systems. Hydropneumatic tanks used in connection with smaller water pumping and distribution systems will absorb some pressure increases but are not designed for surge control.

(4) Pump control valves as part of a surge control system including valve, power and manual valve, operators, accumulator, sensing and recording devices. This system automatically prevents water hammer in starting and stopping of pumps and should include safety features in its design to prevent damage from malfunctioning equipment. Design and operation of the surge control system should be coordinated with the manufacturer.

CHECKLIST OF INFORMATION REQUIRED FOR DETAILED SURGE AND WATER HAMMER ANALYSIS.

1. BASIC SYSTEM DIAGRAM OR SCHEMATIC
 - a. Diameters, lengths, wall thickness of piping elements
 - b. Elevations (pipeline, pump suction/discharge, etc.)
 - c. Valve and fitting locations
 - d. Pump location and arrangements
2. FLUID PROPERTY DATA
 - a. Description of the fluid being transported (potable water)
 - b. Specific gravity
 - c. Bulk modulus of elasticity
 - d. Fluid viscosity
 - e. Temperature
 - f. Vapor pressure

Figure 4-4. Checklist Surge and Water Hammer Analysis

3. PIPELINE DATA
 - a. Type, class, maximum operating pressure, test pressure, allowance
 - b. Pipe material and Young's modulus of elasticity
 - c. Pipeline friction factor (Hazen Williams coefficient, Manning coefficient, Darcy Weisbach friction factor)
 - d. Lengths (Actual lengths only). Equivalent lengths should not be used since minor losses will be lumped into a friction coefficient or a concentrated head loss item as appropriate
4. VALVE DATA
 - a. Size and flow characteristics at various opening (C_v versus angle of opening)
 - b. Valve operator speed and characteristics
 - c. Type of check valves, damped or undamped
 - d. Description of pump station discharge or suction control valves for normal operation and emergency operation
5. PUMP AND DRIVER DATA
 - a. Pump performance data (head, efficiency, horsepower, or torque versus flow)
 - b. Number of stages (for specific speed calculation)
 - c. Changes expected for increased throughput
 - d. Rated conditions (conditions at the best efficiency point for head, flow, speed, and torque)
 - e. Rotar polar moment of inertia WR^2 or equivalent WR^2 , as viewed from the pump end for the driver, coupling, gearbox, pump and enclosed fluid as applicable
 - f. Pump characteristics diagram or synoptic chart (if not available, curves from a pump of similar speed could be used)
 - g. Driver type (induction motor, synchronous motor, turbine, etc.)
 - h. Driver torque versus speed curve (for pump start-up cases)
 - i. Safe current versus time data for electric motors if start-up analysis is to be performed
 - j. Special devices on pump/driver such as non-reverse ratchets, clutches, etc.
 - k. Pump station controls description (minimum flow shutdown, flow discharge pressure shutdown, etc.)
6. OPERATIONAL DATA
 - a. Normal start-up and shutdown procedures
 - b. Emergency operational procedures
 - c. Unplanned operations (inadvertent closures, pump shutdowns, etc.)
 - d. Constraints on pipeline and equipment operation
7. KNOWN BOUNDARY CONDITIONS
 - a. Constant head sources (reservoirs, tanks, etc.) and elevation of liquid surfaces
 - b. Constant flow outlets or inlets
 - c. Other known boundary conditions
8. SURGE SUPPRESSION DEVICES
 - a. For water pipelines—Combination air and vacuum valves plus air release valve option, or air release option only (valve size, type, model number, location, etc.)
 - b. Surge tanks (tank area and height)
 - c. Accumulators (tank volume, initial gas volume, other parameters)
 - d. Relief devices (set pressure, relief devices performance data)
 - e. Specific surge control devices or schemes preferred

Note: Parameters for surge suppression devices will usually be determined by the hydraulic transient studies.
9. REPORT REQUIREMENTS
 - a. Type of report required (letter report or detailed engineering report)—number of copies
 - b. Specific requirements

Figure 4-4. Checklist Surge and Water Hammer Analysis—continued

- 1) Type of pipe: New steel
- 2) Speed of shock wave: (a) 2,690 ft/sec
- 3) Fluid under control: water static head: (H) 20 ft
- 4) Length of main to nearest reservoir: 3,400 ft
- 5) Critical interval:

$$(t) t = \frac{2L}{a} = \frac{2 \times 3400}{2690} = 2.53 \text{ seconds}$$

- 6) Flow (gallons/minute) 5000 discharge line size: 10 in.
- 7) Normal system velocity: (V) 6.48 ft/sec
- 8) Surge head rise for instantaneous closure: (N = 1)

$$\Delta H = \frac{-a\Delta V^*}{g N} = \frac{17431}{(32)(1)} = 544.7 \text{ } \psi$$

- 9) Total head of surge wave: (surge head plus static head)

$$\Delta H + H = 20 + 545 = 565 \text{ ft} = 245 \text{ psi}$$

- 10) Number of critical intervals (t)
- 11) Seconds required for control cycle: (N x t) 1.6 x 2.5 = 4.1 seconds
- 12) Recommended control valve size: ** inches
- 13) Control valve head loss: ** ft

Derived from equations:

$$H - H_0 = F(t - \frac{x}{a}) + f(t + \frac{x}{a})$$

$$V - V_0 = \frac{g}{a} \{F(t - \frac{x}{a}) - f(t + \frac{x}{a})\}$$

Solved simultaneously for instantaneous closure condition: f (t + x)=0

**Consult Manufacturer of Selected Equipment

Figure 4-5. Example Water Hammer Potential Calculation

SYMBOLS	DEFINITIONS
a	Speed of shock wave (ft/sec)
H	Static head (ft)
L	Length of watermain (pipe) (ft)
V	Normal velocity in pipe (ft/sec)
ΔH	Surge head rise (ft)
ΔV	Change in water velocity (ft/sec)
g	Acceleration due to gravity (ft/sec ²)
$\Delta H + H$	Total head of surge wave (surge head + static head)
N	Number of critical intervals (N + 1 for instantaneous closure)

NOTE:

H is for head

t is for time

V is velocity of flow

x is distance

a is acoustic velocity

F and f are functions representing the direct wave reflected wave respectively

Figure 4-5. Example Water Hammer Potential Calculation—continued

CHAPTER 5

PUMPING STATION LAYOUTS

5-1. General. Pumps, piping, and equipment must be protected from the weather as dictated by local climatic conditions. In cold climates pumps and piping must be protected from freezing and are usually completely housed in structures. In warm climates portions of stations may be located in outside enclosures which must provide protection from moisture and other weather related conditions. The impact of noise on the surrounding area and the need for security fencing will be considered for all stations. Structures will be fire-resistive construction, usually of reinforced concrete, steel, and masonry wall construction. Standard windows for unattended remote located stations may be deleted for security reasons, if other provisions such as skylights or high windows are made for natural lighting or if artificial lighting is provided to assist periodic maintenance. The pumping equipment must be located so as not to be subject to flooding. The site will be graded to drain surface water away from structures. Roadway access for maintenance vehicles will be provided at all equipment locations with space provided for vehicle turn around. Buildings will be designed in compliance with local codes and regulations. Building layouts must be designed logically considering the sequence of installation of initial and future equipment if future expansion is planned. Space will be provided for removing equipment for repair without interrupting other equipment. Equipment layouts must provide vertical and horizontal clearances and access openings for maintenance and repair operations. Usually, main aisles will be four feet minimum. Work place safety of operating and maintenance personnel and security of the facility will be considered in the overall pump station design.

5-2. Structural Systems. The foundation design will be based upon a soils analysis and recommendations of a geotechnical engineer experienced in the field of soils mechanics and foundation design. Information on ground water conditions and the classification of soil types will be obtained through borings at the pump station location. For below grade structures the soils survey will be performed during the time of year when ground water is at its highest. Conditions to be considered in the design will be not only soil bearing qualities, but also soil swell potential and ground water infiltration into the structure through the lowest point of entry

which will be either a pipe penetration or a joint in the concrete. Usually ground water should be at least one foot below the lowest point of entry. The structural design layout will show design of pipe anchors and pipe supports under pump operating conditions, and foundations under heavy equipment. Structural steel will be provided to support piping and conduit. Reinforced concrete bases raised above the floor will be provided for pumps, engine drives, large meters, large valves and control devices, and floor mounted electric equipment. Centrifugal pumps and driver will have common foundation and base plate. Refer to TM 5-805-4 for noise and vibration control for equipment installations. Floors will slope to floor drains located around all pumps. Floor loading will consider moving large equipment in and out for repair, maintenance, and replacement. Crane rails and traveling overhead hoists will be provided in large pump station buildings where use of temporary or portable hoisting equipment is not practical for maintenance, repair, and equipment removal operations. Sufficient headroom must be provided to allow equipment being removed to clear other equipment. A removable hatch, hinged hatch, or removable roof panel may be considered for removal of vertical long stem equipment. Split floor levels will be avoided where possible. Where different floor levels are necessary, standard stair design will be used and safety railing provided in accordance with OSHA standards.

5-3. Mechanical Equipment. Equipment layout will provide space for safe maintenance and operation of equipment. A typical pumping piping layout of a main pump station is shown in figure 5-1. Valves, meters, gauges and control devices will be located to be accessible without use of ladders, or use of chain wheels. Floors, gratings, and plates will be nonslip. Floor drains and pump gland drains will be provided in pump areas. Below grade equipment structures which cannot be drained by gravity piping will be provided with sump pumps. Engines may be located in separate buildings or in outdoor enclosures in warmer climates. Engines will be provided with adequate combustion air. Engines will have a cooling system, fueling system, lubrication system, electric starting system with battery charging, safety controls, and instrument and control panel as required for system operation. Fuel tanks will be located above ground where

possible with fuel spill protection and containment. Exhaust system with mufflers will be provided for engine exhaust. The noise level of running engines and impact on surrounding occupancies will be considered in locating engines and direction of exhaust stack. Extinguishers for fire protection will be provided. Safety guards will be provided on moving and rotating parts of all equipment. Storage facilities for equipment parts and tools for equipment maintenance will be provided. Refer to Figure 5-2 for typical sections through a pump station.

5-4. Electrical. Switchgear, electrical panels, instrument panels and other controls will be located where convenient to operation personnel, where good visibility is provided, and away from possible floor flooding. Maintenance and operating space will be provided for all electrical gear. Generally, natural lighting at major pumping units and electrical pump control equipment will be provided. Artificial lighting with average 30 foot candle in main pump room will be provided. Additional localized lighting will serve instruments, control

panels, gauges, and other devices routinely used to control pump station operation. Exterior lighting at doors, at exposed pump station control devices, and for area security will be provided. Convenience outlets will be provided for use by maintenance personnel. Emergency lights with battery power backup will be provided at critical control devices. Motor control systems with hand-off-automatic switches and motor protection devices for pump motors will be provided. Enclosures will be NEMA enclosure types to suit location.

5-5. Building Environmental Systems. Heating will be provided to prevent damage to equipment by condensation and to provide comfort conditions for operating personnel. Air conditioning will be provided in climates where humidity will cause damage to instruments and controls, and in any office areas in the larger main pump stations in geographic areas where ambient temperature and humidity requires comfort air conditioning. Ventilation will be provided for all areas not requiring comfort air conditioning or dehumidification and in below ground structures.

CANCELLED

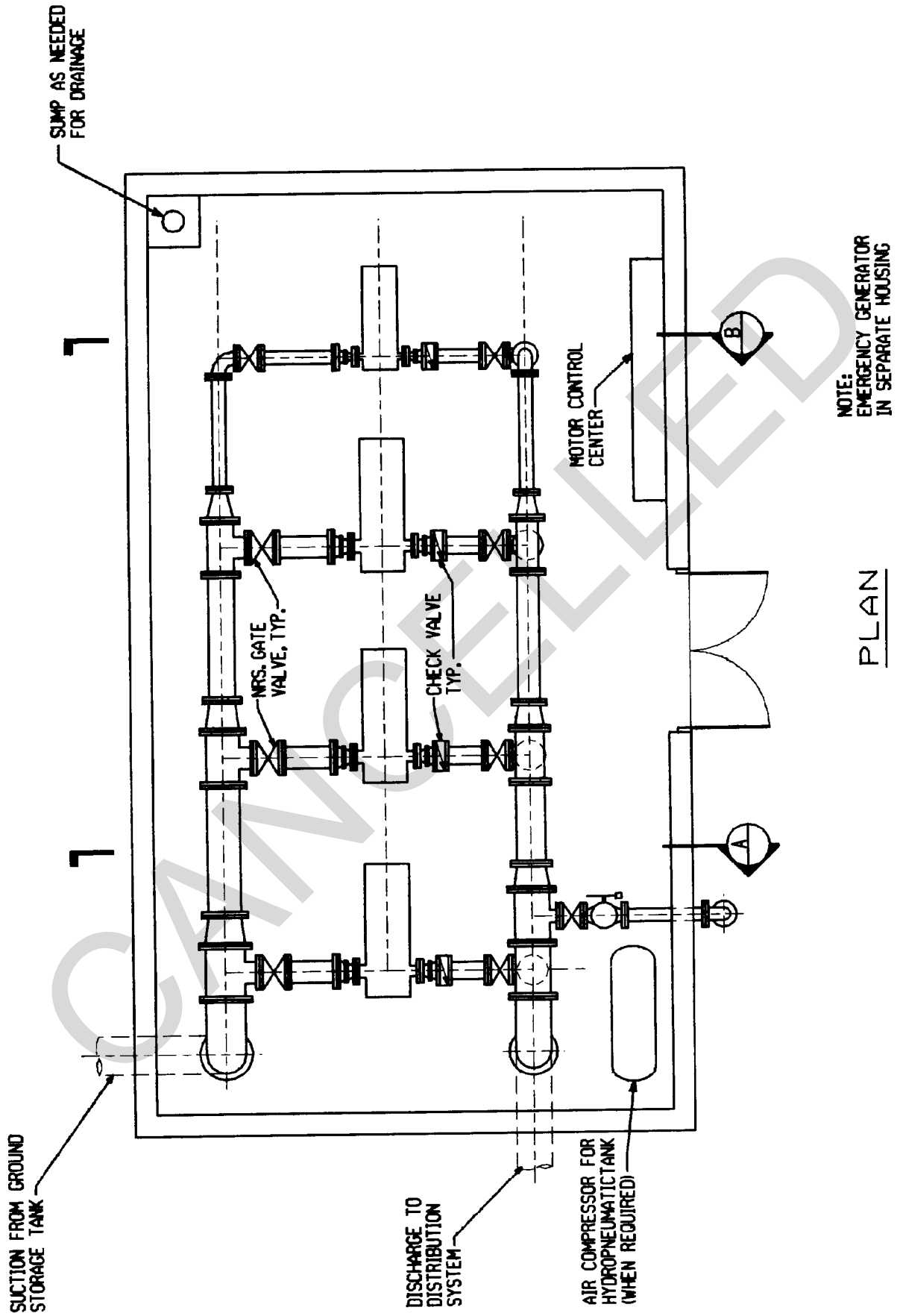
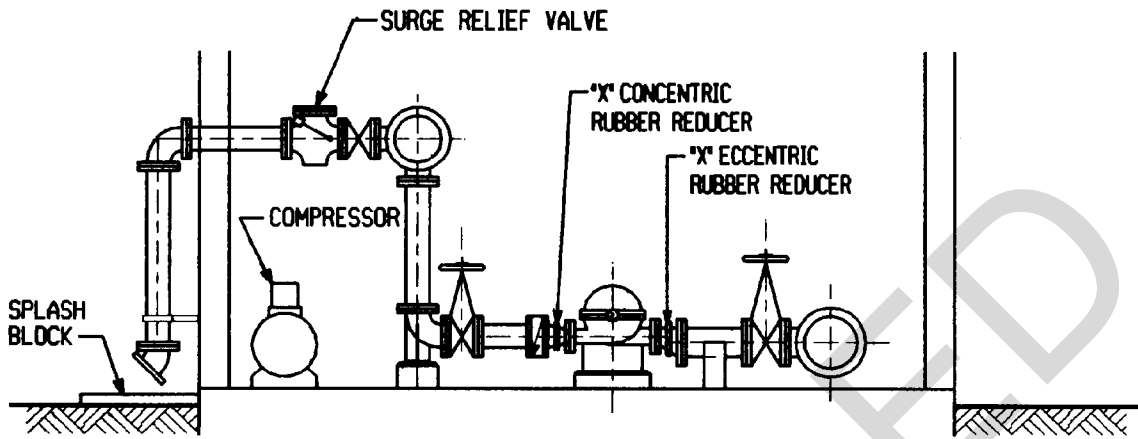
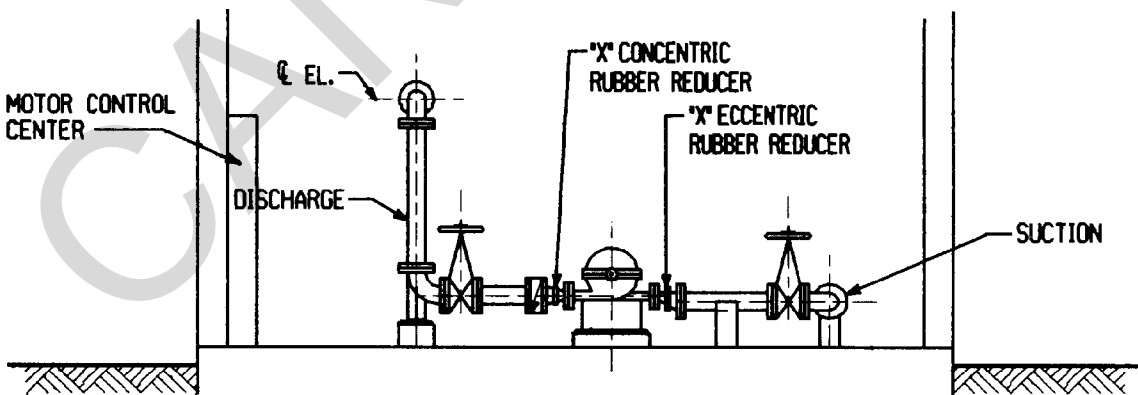

Figure 5-1. Pumping Station Typical Layout



A SECTION



B SECTION

Figures 5-2. Pumping Station Sections

CHAPTER 6

OPERATING EFFICIENCIES

6-1. General. Water pumping stations will normally operate automatically to satisfy the hydraulic requirements of the system. Supervisory or remote control of electric motors will be provided on the larger installations to reduce operator time and to provide a means for optimal control of energy costs, and to allow for energy conservation measures. For optimal control of energy costs, particularly for larger pump stations, the control system will allow the operators to schedule pump operations so that station electrical consumption is minimized at the same time adequate storage for fire protection and system pressures are maintained. Energy costs comprise the major component of the operating costs of water supply systems. The largest quantity of energy is usually consumed by treated water pumping stations. The overall operating cost associated with a particular pump station will be dependent upon the following factors: the pumps, the distribution system, the pump drivers, and the governing energy rate schedule. The design analysis for the distribution system and pump station and the cost evaluation will consider these factors.

6-2. Pump Operations. Three different problem areas are usually encountered in any attempt to improve pump operations of an existing pump station: inefficient pumps, inefficient pump combinations, and inefficient pump scheduling. The efficiency of a single pump is the ratio of water horsepower produced by the pump to the input horsepower, usually electrical. This efficiency should be measured at several flow rates. It is not always physically practical to measure flow rates after pumps are installed in existing installations. However, if this information can be obtained and the pump is shown to satisfy its original performance specification, there is still no assurance that it will operate efficiently in the system. The efficiency of a pump running alone can be much different than when running in conjunction with other pumps. With multiple pump operation the actual flow produced will depend upon the head differences between the suction header and discharge header. The relationship between these heads and the flow rate is referred to as the system head curve and is a function of tank water level on each size of the pump, pipe carrying capacity near the pump, location of water users with respect to the pump, and which other pumps are operating.

Depending on the system head encountered by a pump, the pump may perform over a wide range of efficiencies.

6-3. Pump Scheduling. Pump scheduling for optimum energy costs for large pump stations with elevated storage can be established by use of computer programs where accurate input data reflecting existing system operations can be obtained. The total energy consumption charges associated with a pump operation can be decreased by improving the efficiency of individual pumps or combination of pumps. However, such measures have little impact on reducing the costs associated with time of day energy rate schedules. The primary way to minimize the cost associated with variable electric rate schedules is through use of off-peak pumping strategies. This policy should be implemented if energy savings exceed the cost of additional storage capacities. The key to implementation of an off-peak pumping schedule is the availability of equalizing storage and the development of an optimal pump operating policy. A pump operating policy is a schedule of water levels that should be maintained and a series of rules that dictate when different pumps should be operated in response to different system conditions. The pump operating policy might consider time of year as well as time of day. As an example, no pumping when the ambient temperature falls below a preset temperature during cold months during the period when electricity usage is the highest. An optimal pump operating policy is that policy which will satisfy all constraints at a minimum cost.

6-4. Ease of Operation and Maintainability. The design of pumping equipment and drives will be evaluated based on several factors: amount of operator attention, frequency of routine maintenance and adjustment, energy savings, and availability of parts and service. Proper alignment of pump and driver, as well as support of suction and discharge piping will help prevent some noises and vibration. Noise is minimized by choosing pumps to operate near the point of best efficiency and proper suction conditions. Increased vibration affects the life of bearings, stuffing boxes, and mechanical seals. Partially closed valves will not only increase noise, but will increase radial thrust and resultant stresses in shafts and bearings of centrifugal pumps.

APPENDIX A

REFERENCES

Government Publications

Departments of the Army and the Air Force

<p>TM 5-813-1/AFM 88-10, Vol.1</p> <p>TM 5-813-4/AFM 88-10, Vol.4</p> <p>TM 5-813-5/AFM 88-10, Vol.5</p> <p>TM 5-813-7/AFM 88-10, Vol.7</p>	<p>Water Supply: Sources and General Considerations</p> <p>Water Supply: Water Storage</p> <p>Water Supply: Water Distribution</p> <p>Water Supply for Special Projects</p>
---	---

Non-Government Publications

American Water Works Association (AWWA), 6666 W. Quincy Avenue,
Denver, CO 80235

<p>C701-88</p>	<p>Cold Water Meters — Turbine Type for Customer Service</p>
----------------	--

<p>C704-70</p>	<p>Cold Water Meters-Propeller Type for Mainline Applications</p>
----------------	---

Hydraulic Institute, 9 Sylvan Way, Suite 360, Parsippany, NJ 07054-3802

Hydraulic Institute Engineering Data

Book, Second Edition (1990)
Hydraulic Institute Standards for Centrifugal, Rotary & Reciprocating Pumps, Fourteenth Edition (1983)

National Electrical Manufacturers Association (NEMA), 2101 L Street,
NW Suite 300, Washington, DC 20037

<p>NEMA MG 1 (1987; Rev.1)</p>	<p>Motors and Generators</p>
--------------------------------	------------------------------

National Fire Protection Association (NFPA), One Batterymarch Park,
P.O. Box 9101, Quincy, MA 02269-9101

<p>20-90</p>	<p>Standard for the Installation of Centrifugal Fire Pumps</p>
--------------	--

APPENDIX B

AVAILABLE MICROCOMPUTER PROGRAMS

This appendix describes briefly computer programs, available to the general public, that perform hydraulic analyses applicable to the types of problems presented in this manual. The programs are designed to run on IBM compatible microcomputers. This list is not intended to be exhaustive. The information given on the programs are derived from the information provided by the software vendors. This information has not been verified, nor is the inclusion of a program in this listing an endorsement by the U.S. Government. Persons desiring computer programs should contact the vendor directly to determine if the program is suitable for the intended usage, the pricing of the programs and the method of procurement (i.e., purchase or leasing).

HYDRAULIC TRANSIENT ANALYSIS

Program name: P TRANS

Company: Pipeline Hydraulics Engineering, Inc.
1301 NW Freeway, Suite 310
Houston, Texas 77040

Description: The following analyses are routinely conducted:

1. Pump Start-Up and Failure
2. Valve Closure
3. Check Valve Slam
4. Control Valve Operation
5. Surge Relief Valve Sizing
6. Surge Relief Packaging Design
7. Resonance Studies

Program Name: LIQT Service

Company: Stone Associates, Inc./DRGM, Incorporated
5177 Richmond Avenue #1075
Houston, TX 77056-6736

Description: Simulation of transient (unsteady) flow in piping systems carrying liquids.

PIPE NETWORK FLOW ANALYSIS

Program Name: KYPIPES

Company: Haestad Methods, Inc.
37 Brookside Road
Waterbury, CT 06708

Theory Supported by:

Don J. Wood
Department of Civil Engineering
University of Kentucky
Lexington, Kentucky

Description: The program models water distribution systems. The pipe network system is defined with input data for pipes, fixed grade nodes, pressure relief valves, pressure switches, pumps, and storage tanks. Pumps can be installed anywhere in the network and are described by entering three operating points for discharge versus head. It can model extended period simulation for the entire system by making system changes including turning pumps on and off.

Program Name: CYBERNET

Company: Haestad Methods, Inc.
37 Brookside Road
Waterbury, CT 06708

Description: Pressure flow distribution modeling, computer aided design. CYBERNET is compatible with KYPIPES and is a comprehensive modeling tool that integrates AutoCad with advanced mapping and graphics extensions. Will adjust pressure contour to account for elevations of the surrounding terrain, yielding an accurate prediction of available pressures throughout the system.

ENERGY EFFICIENCY

Design engineers may obtain information on available computer programs on energy efficiency at water pump stations from a report entitled "A Computer Program for Optimal Control of Water Supply Pump Stations: Development and Testing", by D.V. Chase, CERL TR-N-90/14, August 1990, ADA226689. The report can be purchased from the National Technical Information Service, Springfield, Virginia 22161.

COMPUTER PROGRAMS FOR DISTRICT ENGINEERS

Information on computer programs and services available for hydraulic analysis of water distribution systems may be obtained from the CADD Center at Department of the Army, Waterways Experimental Station (WES), Corps of Engineers, P.O. Box 631, Vicksburg, Mississippi 39180-0631.

CANCELLED

APPENDIX C

CASE STUDY FOR ADDING PUMPS TO AN EXISTING SYSTEM

C-1. The impact on existing system performance was analyzed for adding three new pump stations to handle peak flow requirements in 15 years. A summary of the case study is as follows:

a. The existing system included the following elements:

- (1) Seven wells and pumps as the supply source.
- (2) Network of distribution mains served by feeder mains from seven points of supply.
- (3) Storage facilities included an underground reservoir and three elevated tanks riding on the system.

b. A mathematical model network was developed based on extensive field testing and survey of actual sting operating conditions to be used for the hydraulic analysis of the system to handle present and future demands in 15 years. Figure C-I identifies the system.

C-2. The analysis of the existing system concluded the following deficiencies:

a. Existing wells and distribution system would be unable to deliver the normal daily demands in 15 years and grossly deficient to deliver fire flow demands.

b. Pressures would be inadequate at the peak flow rate and to satisfy fire flow requirements. Figure C-2 shows the pressure contour map.

c. On the basis of established criteria for the system, the system storage was deficient.

d. System performance for the extended period was analyzed and the following improvements to overcome the deficiencies were recommended:

- (1) Three underground reservoirs for additional storage.
- (2) A surface water supply source with delivery to the three underground storage reservoirs.
- (3) A pump station at each proposed reservoir.
- (4) Additional means for fire protection in remote areas.

e. The following findings were derived from these analyses:

(1) The improved system would generally result in increased pressure throughout the service area. The minimum pressure in the network model increased approximately 10 psi. Refer to figure C-3 for improved distribution system contour map.

(2) The hydraulic network analysis also determined the supply point. This information was used to establish the storage requirements at each reservoir site and to select pumps for the pumping stations at these locations.

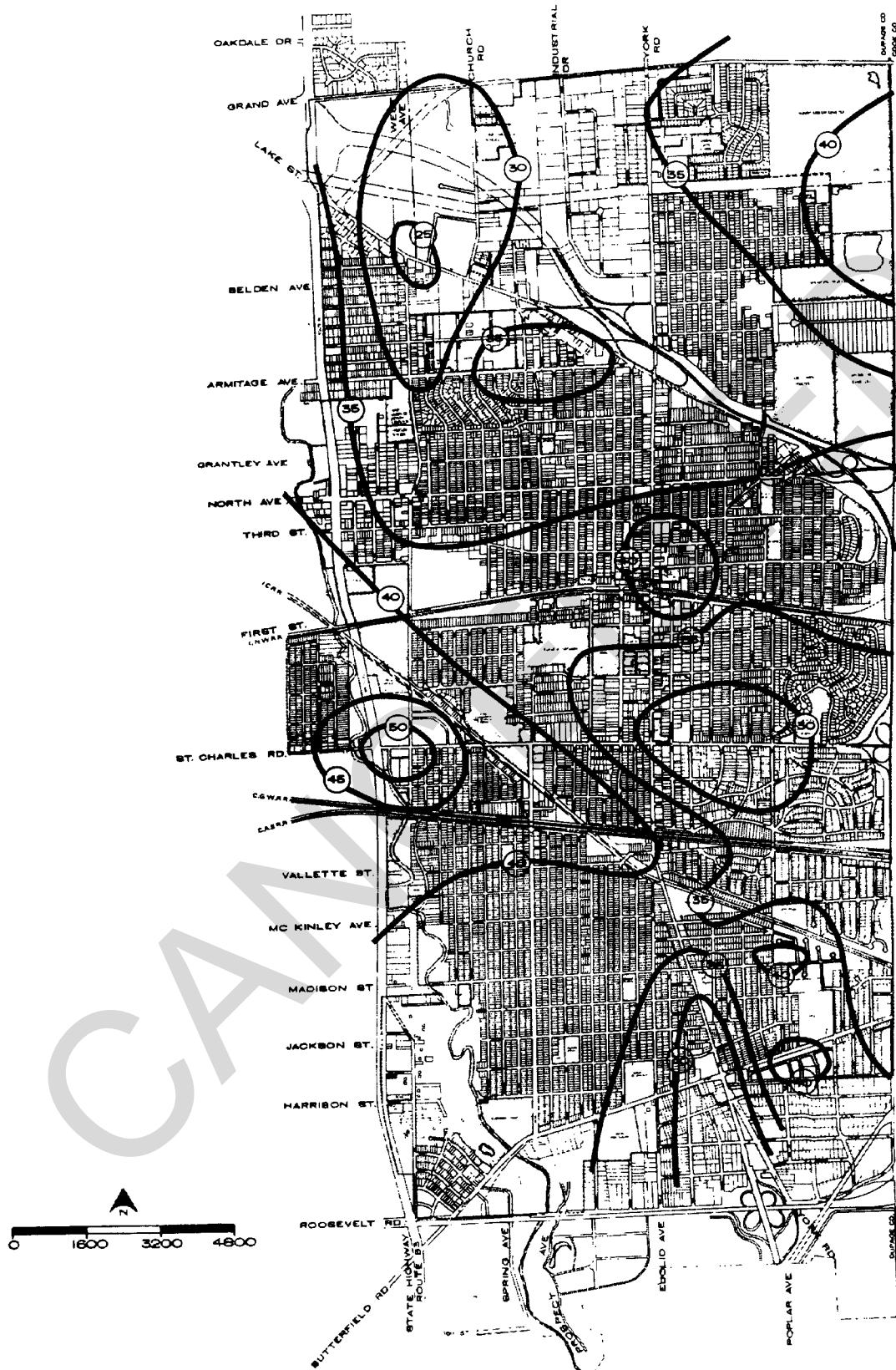

Figure C-2. Existing Distribution System-Maximum Daily Consumption.

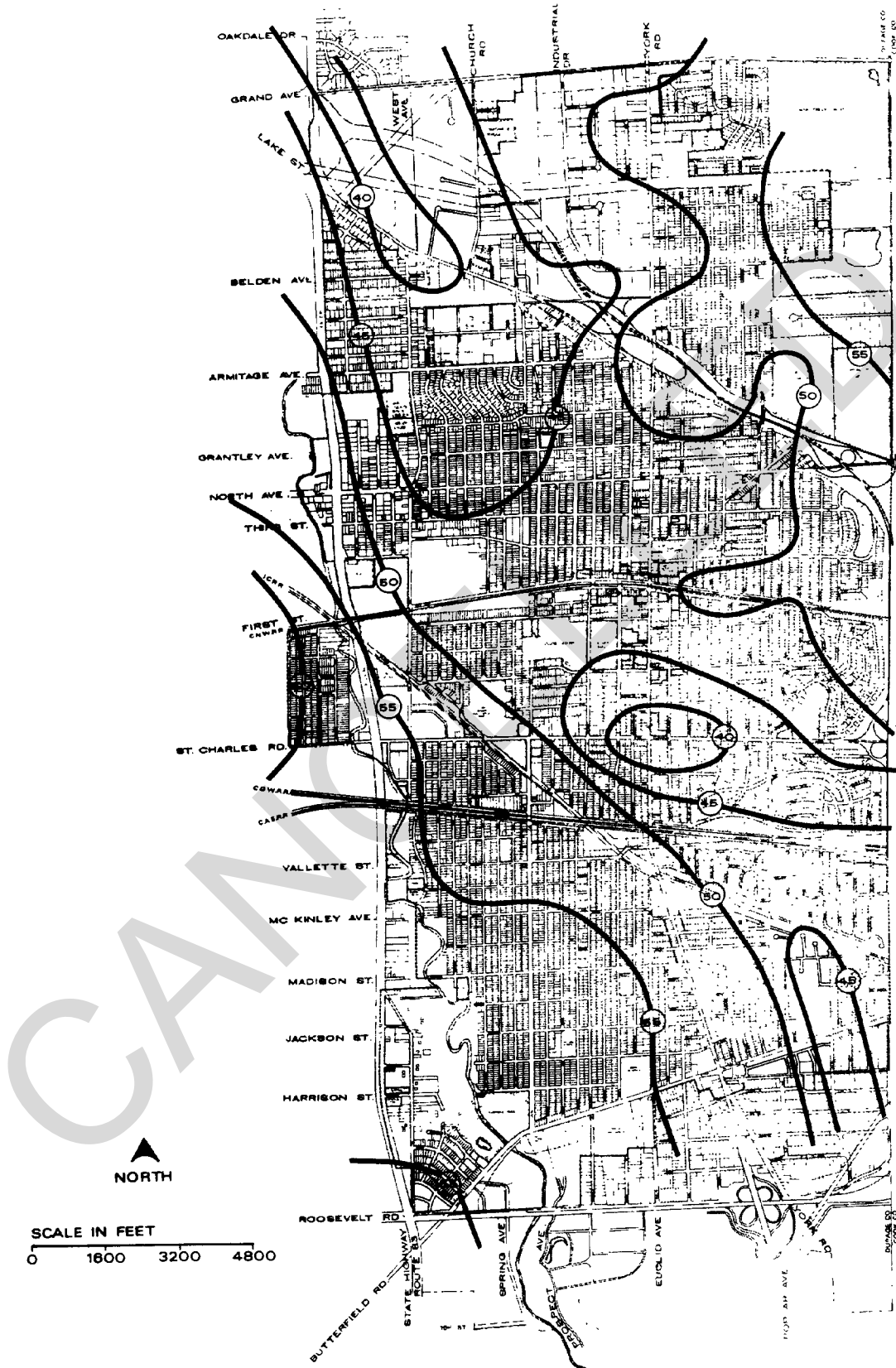

Figure C-3. Improved Distribution System-Maximum Daily Consumption.

APPENDIX D

CASE STUDY FOR HYDRAULIC TRANSIENTS

D-1. In a typical water pump station operating on suction level control, pump stop and restart occurs several times each day. Pump shutdown is the most common cause of hydraulic surge pressures or hydraulic transients in this type of system. Valve closure surges may be less frequent.

D-2. Figure D-1 illustrates a typical pressure/time history obtained at the pump discharge manifold of a pumping station following pump shutdown. As the pumps stop, flow into the pipeline drops rapidly; but the column of liquid in the line continues under its own momentum leaving behind a low pressure region. Eventually the momentum is overcome by the opposing force of static head which in turn accelerates the liquid column back towards the pumping station. The pump discharge check valves close in this interim period and a rapid pressure rise occurs when reverse flow impacts on the closed check valves approximately 6 seconds after pump shutdown. The pump discharge check valves close in this interim period and a rapid pressure rise occurs when reverse flow impacts on the closed check valves approximately 6 seconds after pump shutdown.

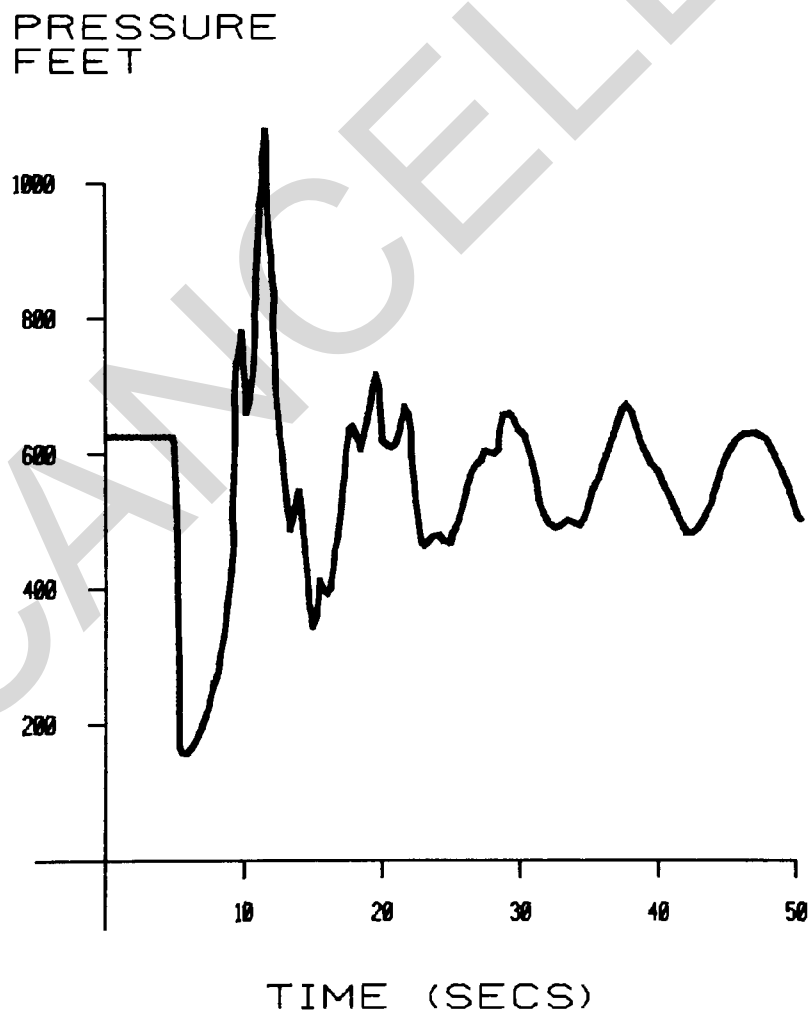

Figure D-1. Uncontrolled Surge.

D-3. The magnitude of the initial pressure drop and subsequent surge pressure is influenced by the initial pipeline velocity, the static head, the pipeline length, pressure pulse wavespeed, and friction. The system illustrated has over 550 feet (238 PSIG) static lift which produces the reverse accelerating head to cause a peak pressure of 1085 feet (470 PSIG). The peak pressure is attenuated to some degree by the action of air valves on the pipeline which opened when the initial pressure drop or downsurge traversed the system. This, together with the interaction of velocity changes in the pipeline, causes the inflections in the pressure history shown in the plot.

D-4. Figure D-2 illustrates the effectiveness of an air vessel or accumulator on the same system. Rapid velocity changes are prevented following pump shut down; instead water flows from the air vessel and the pipeline flowrate drops steadily. In turn, the pressure falls slowly and mass oscillation develops between the air vessel and the pipeline terminus.

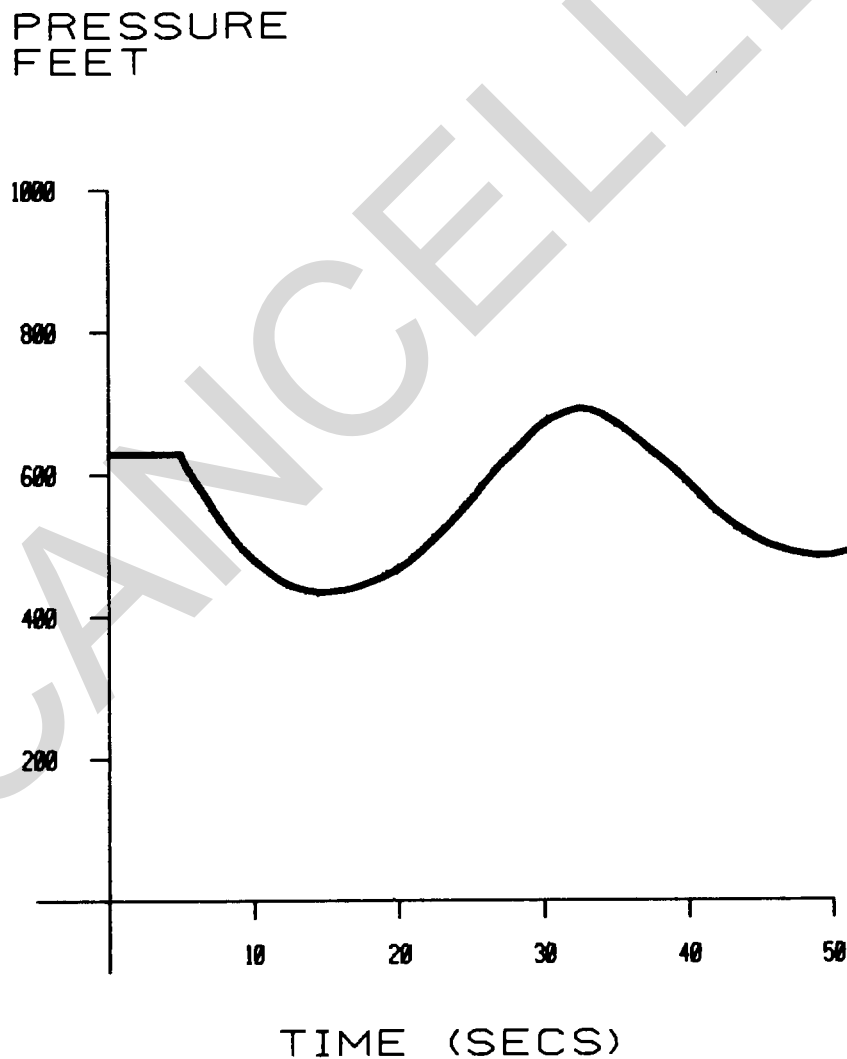

Figure D-2. With Air Vessel.

D-5. Alternatively, surge pressures may be reduced by provision of a pressure relief valve at the pumping station as illustrated in figure D-3. The initial effects of pump shutdown are unaltered but the relief valve opens as flow reverses towards the station. Flow impact on the closed check valves is therefore avoided and surge pressures are reduced to 637 feet (276 PSIG).

D-6. This case study illustrates the fact that an uncontrolled surge due to pump shutdown, in combination with an arbitrary factor of safety for the pipeline and check valve pressure ratings could cause system failure.

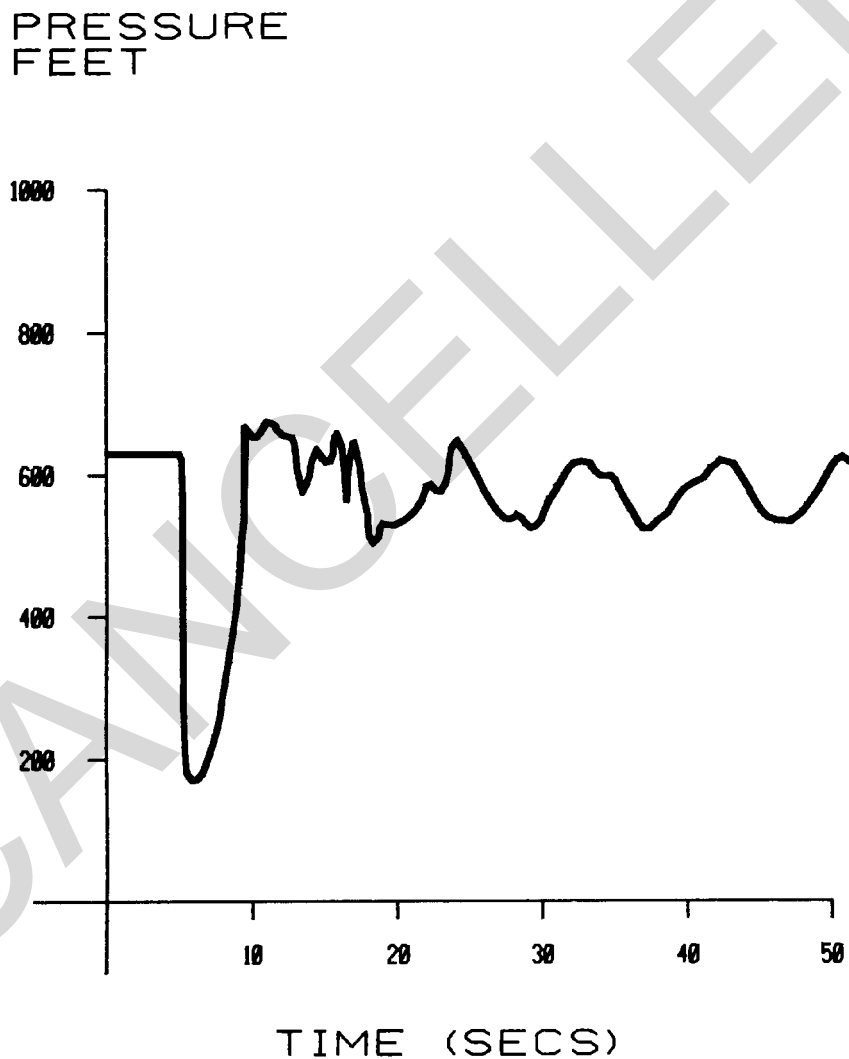

Figure D-3. With Pressure Relief Valve.

BIBLIOGRAPHY

Chase, Donald V., *A Computer Program for Optimal Control of Water Supply Pump Stations: Development and Testing*. U.S. Army Construction Engineering Research Laboratory, Champaign, IL, August 1990.

Gessler, Johannes, and Walski, T. M., *Water Distribution System Optimization*, U.S. Army Engineer Waterways Experiment Station, Vicksburg, MS, October 1985.

Mays, L. W., and Cullinane, M. J., *A Review and Evaluation of Reliability Concepts for Design of Water Distribution Systems*, U.S. Army Engineer Waterways Experiment Station, Vicksburg, MS, January 1986.

Ormsbee, L. E., et al., *Techniques for improving Energy Efficiency at Water Supply Pumping Stations*, U.S. Army Engineer Waterways Experiment Station, Vicksburg, MS, November 1989.

Walski, T. M., Sharp, W. W., and Shields, F. D., *Predicting Internal Roughness in Water Mains*, U.S. Army Engineer Waterways Experiment Station, Vicksburg, MS, February 1989.

American Water Works Association (AWWA), 6666 W. Quincy Avenue, Denver, CO 80235. (Note these standards are periodically updated, contact AWWA for latest issue). M11-1989, *Steel Pipe-A Guide for Design and Installation, Chapter 5 Water Hammer and Pressure Surge*.

The proponent agency of this publication is the office of the Chief of Engineers, United States Army. Users are invited to send comments and suggested improvements on DA Form 2028 (Recommended Changes to Publications and Blank Forms) to HQUSACE (CEMP-ET), WASH DC 20314-1000.

By order of the Secretary of the Army:

GORDON R. SULLIVAN
General, United States Army
Chief of Staff

Official:

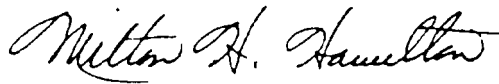

MILTON H. HAMILTON
Administrative Assistant to the
Secretary of the Army

Distribution:

To be distributed in accordance with DA Form 12-34-E, requirements for TM 5-813-6.

CANCELLED