

26 05 33 - LAYOUT 1 (IP)
600V SHIP SERVICE POWER CONNECTION STATION

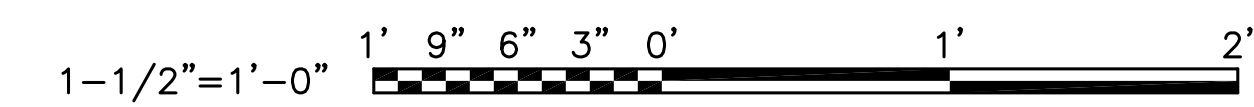

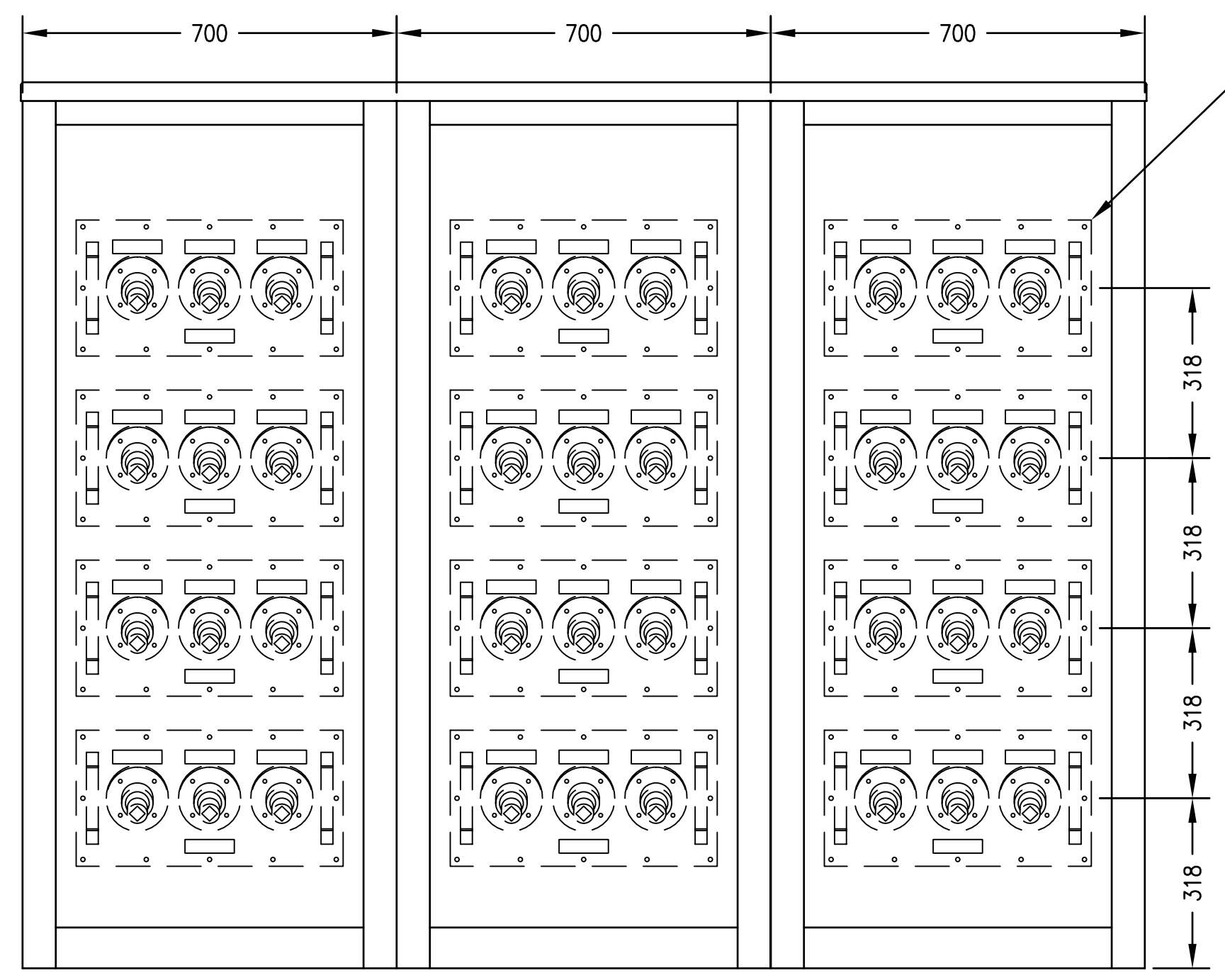

FRONT VIEW

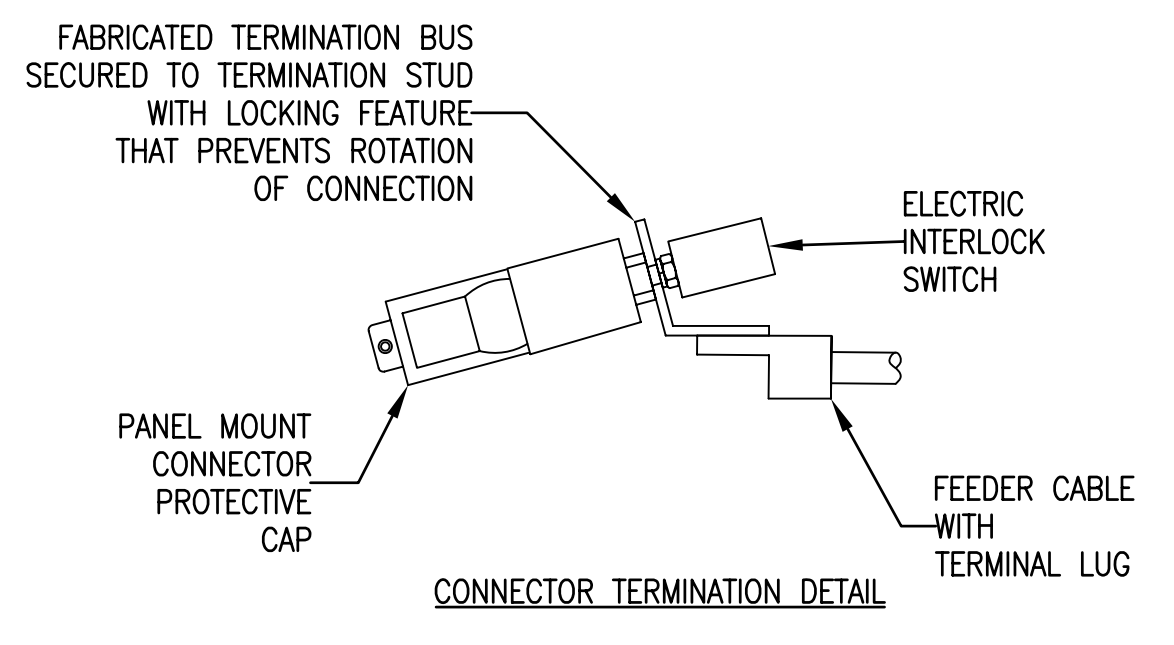
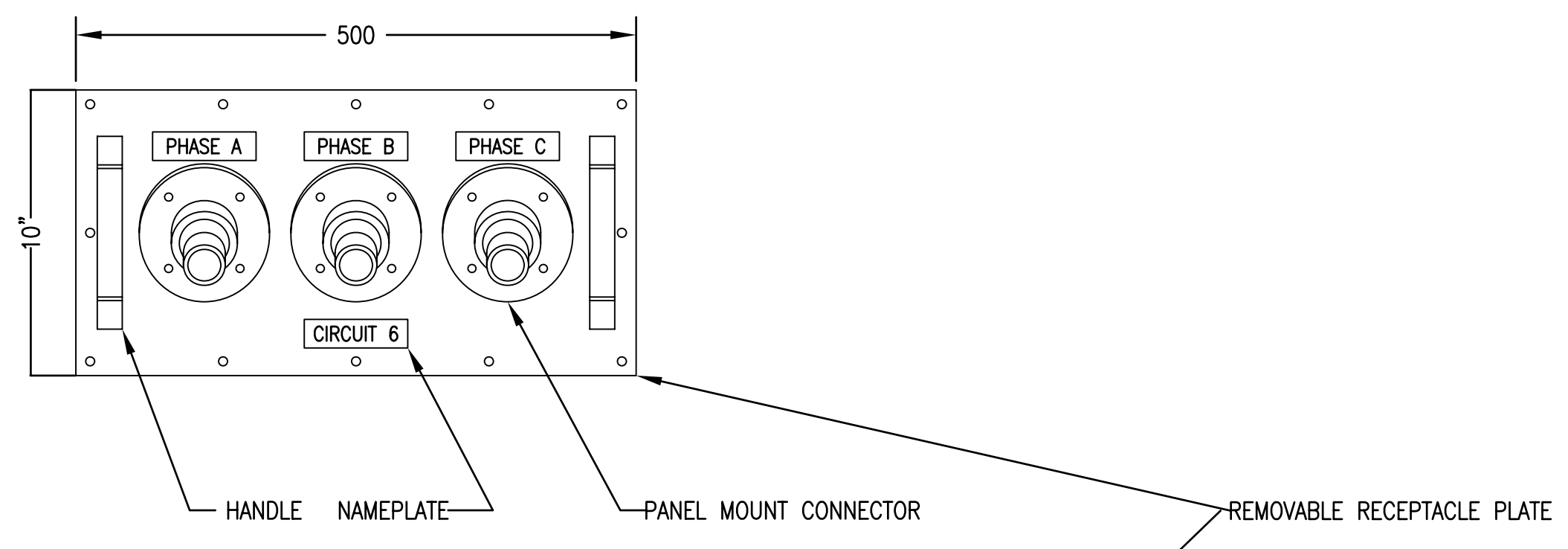
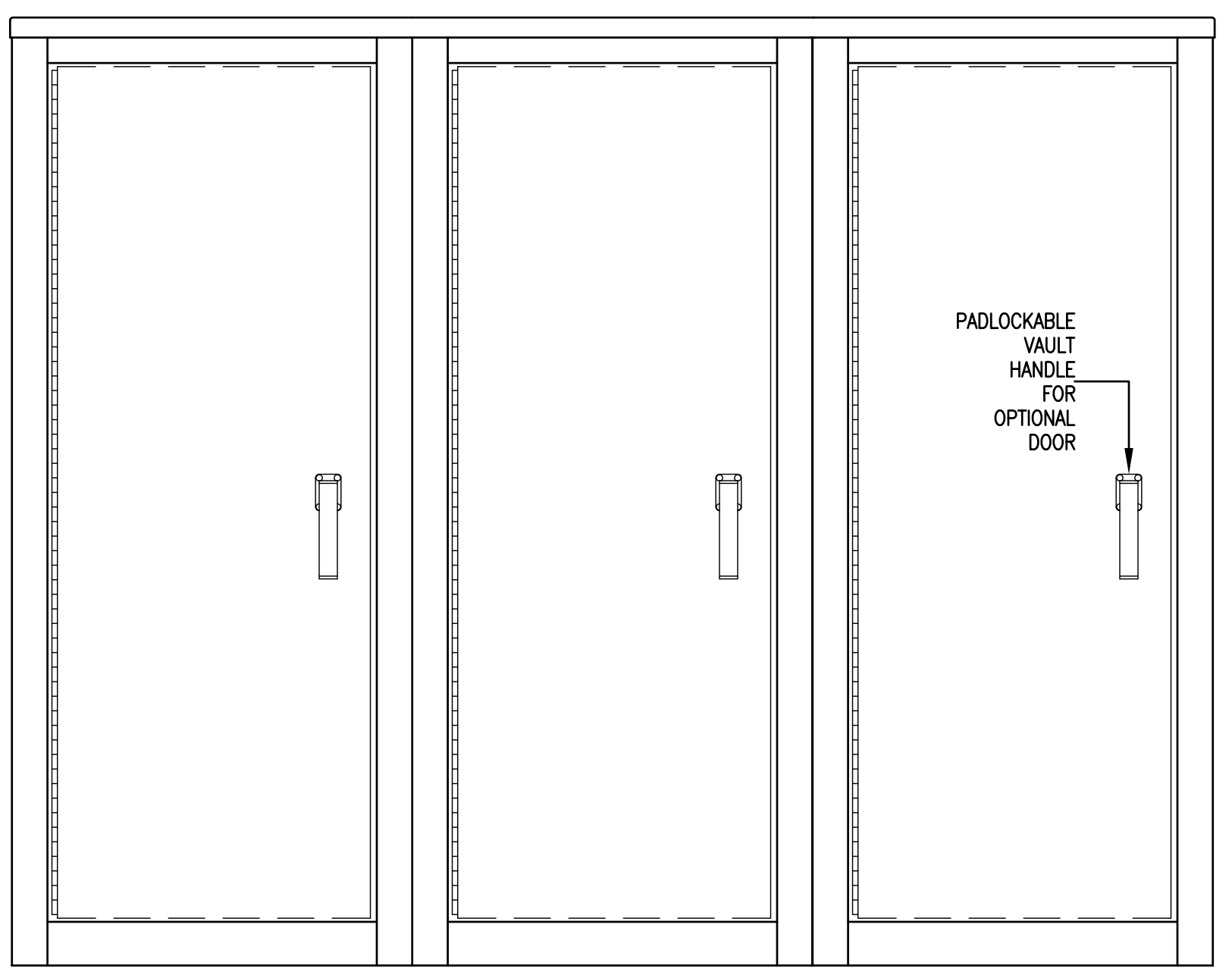

FRONT VIEW WITH OPTIONAL DOORS

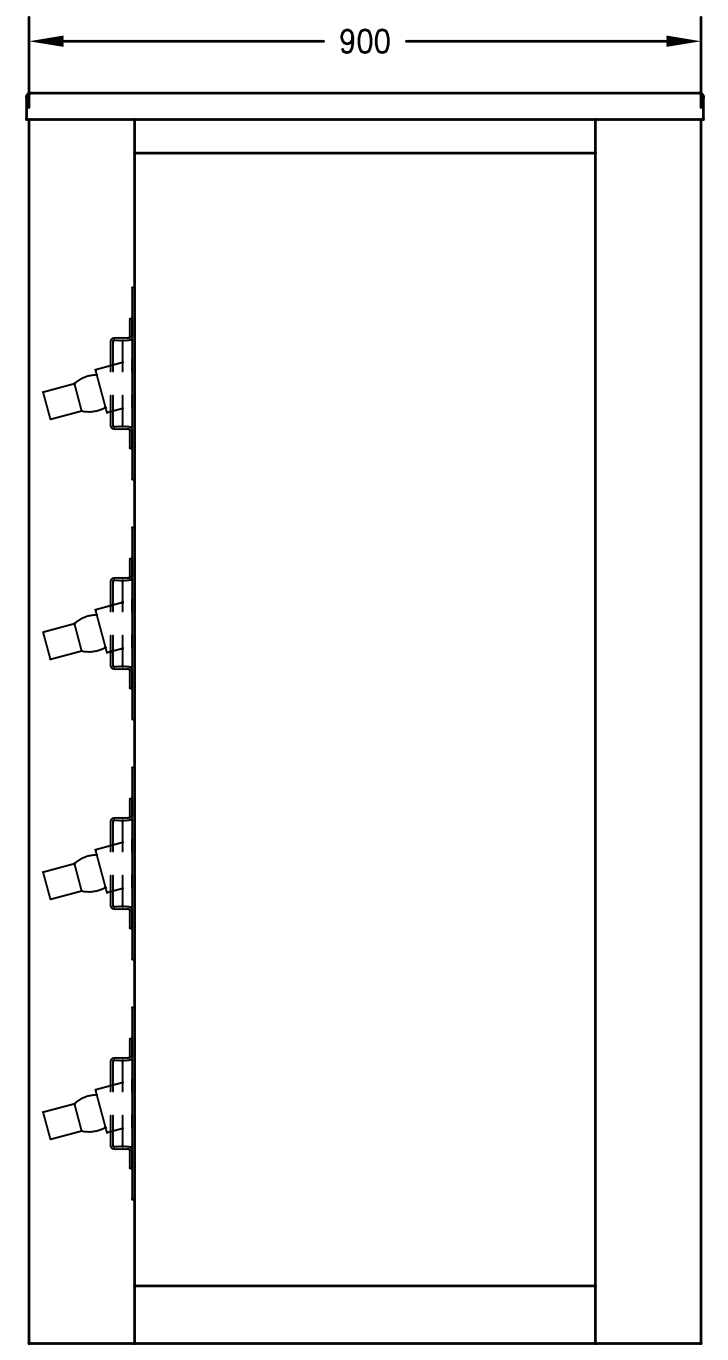

RIGHT SIDE VIEW

26 05 33 - LAYOUT 1 (SI)
600V SHIP SERVICE POWER CONNECTION STATION

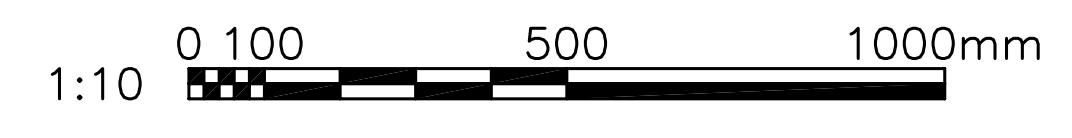

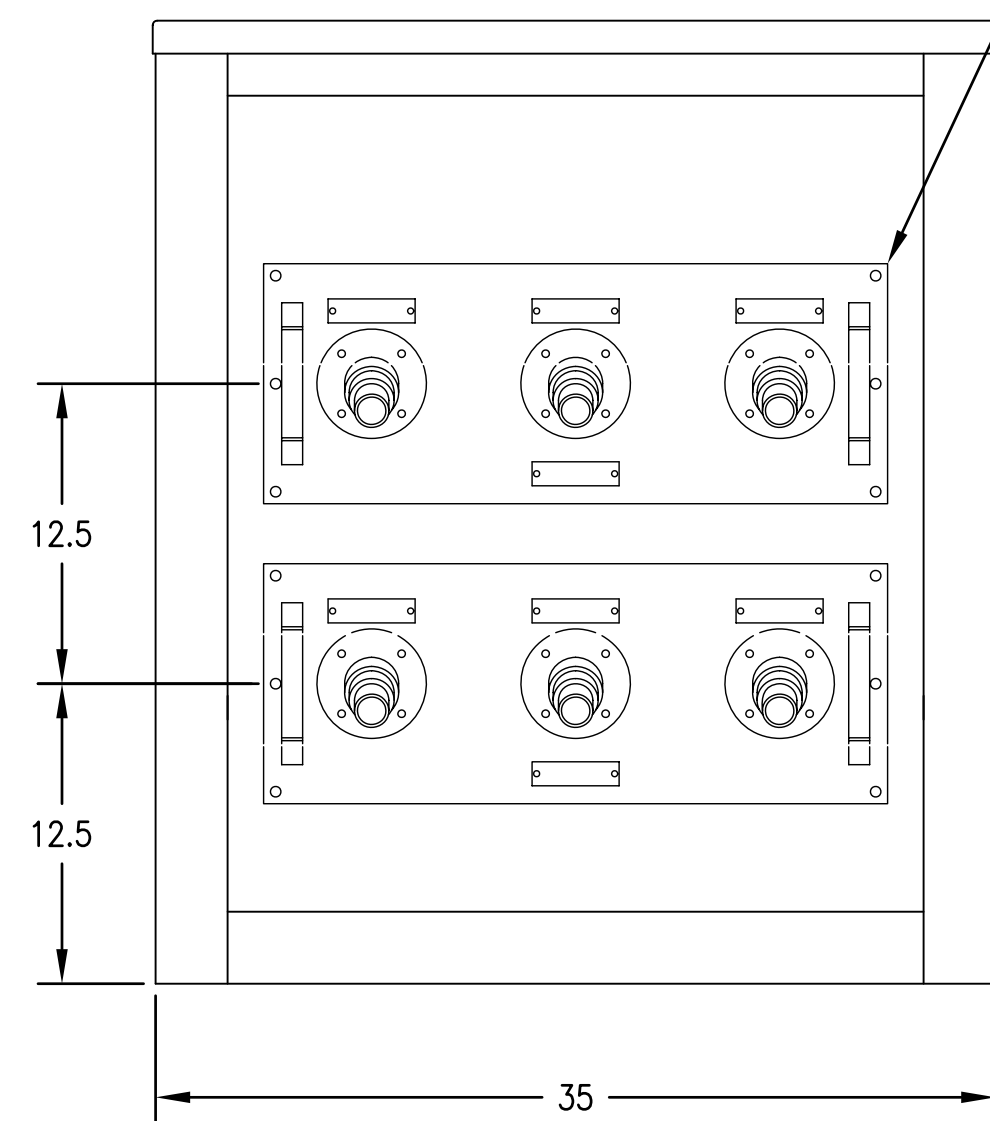
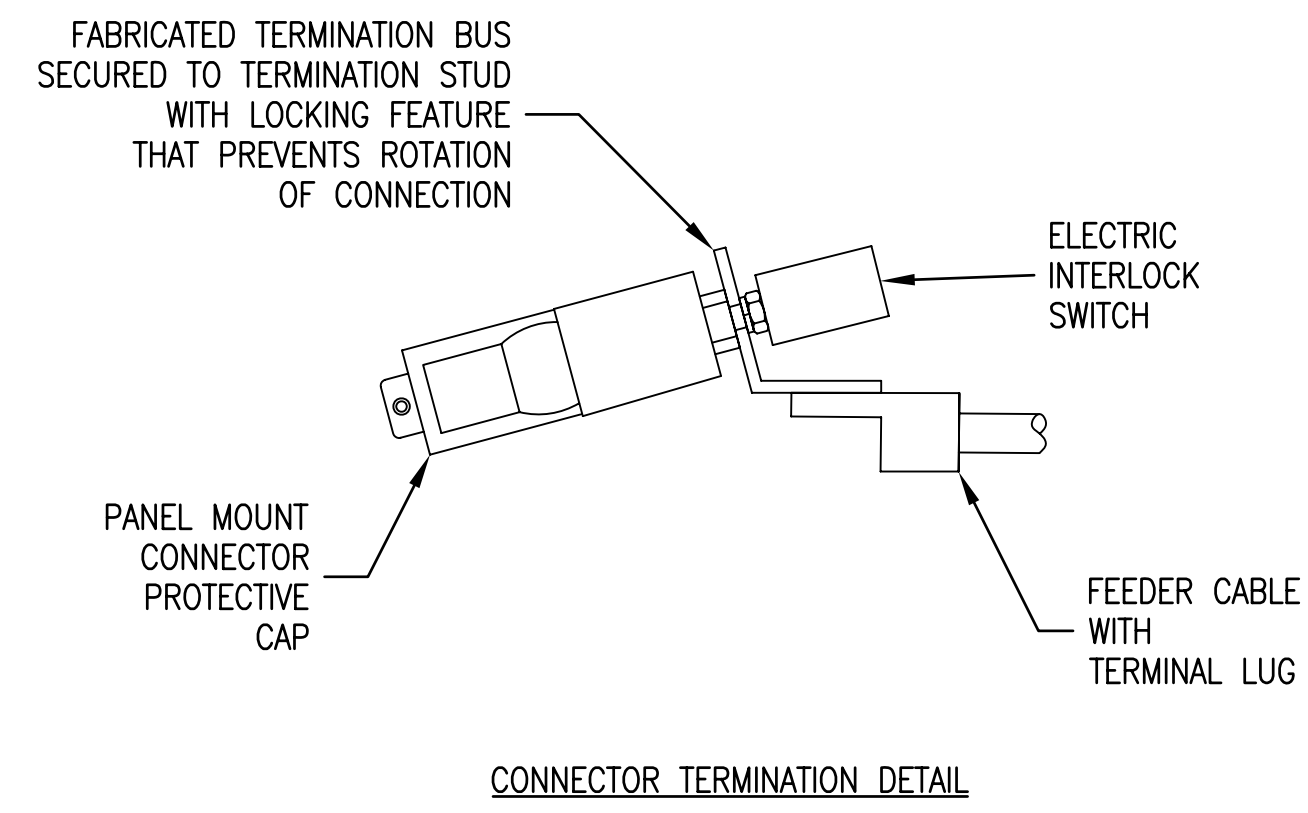
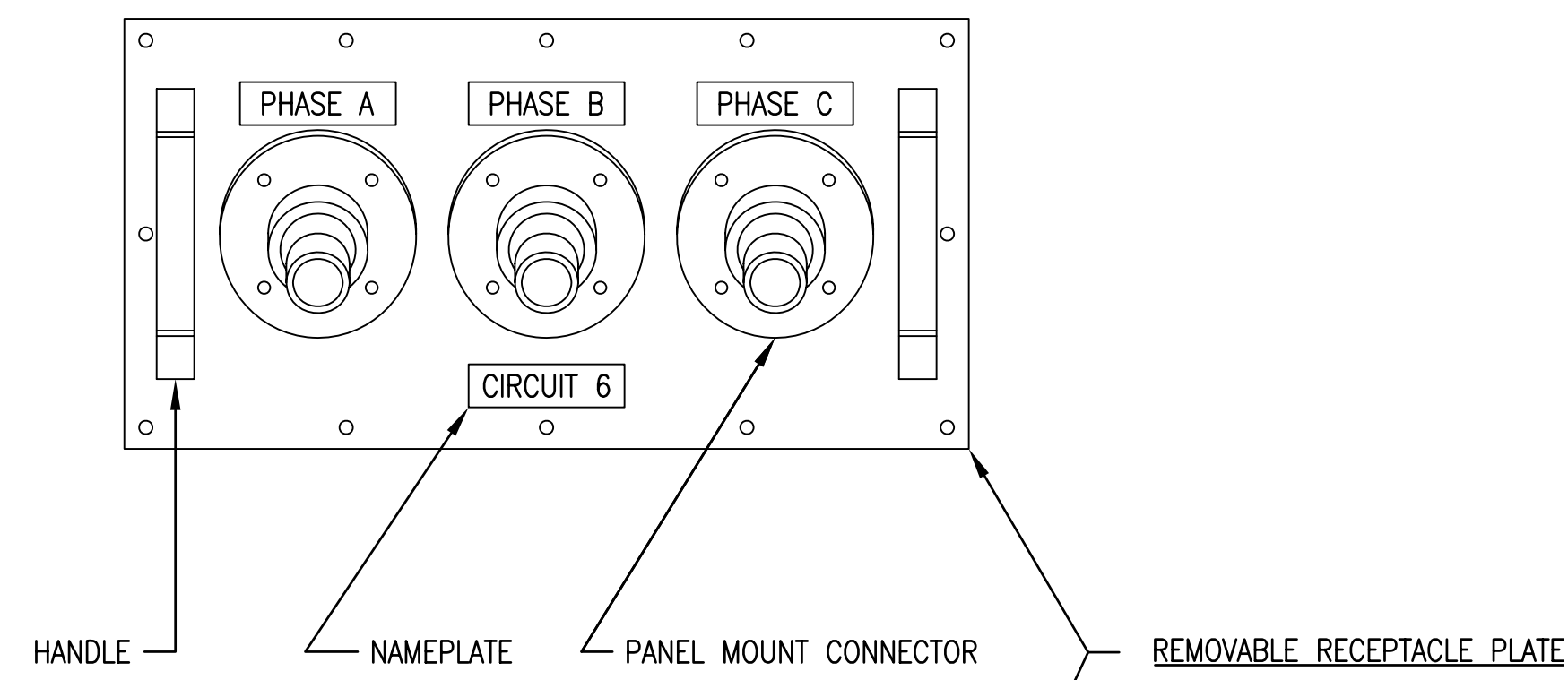

FRONT VIEW

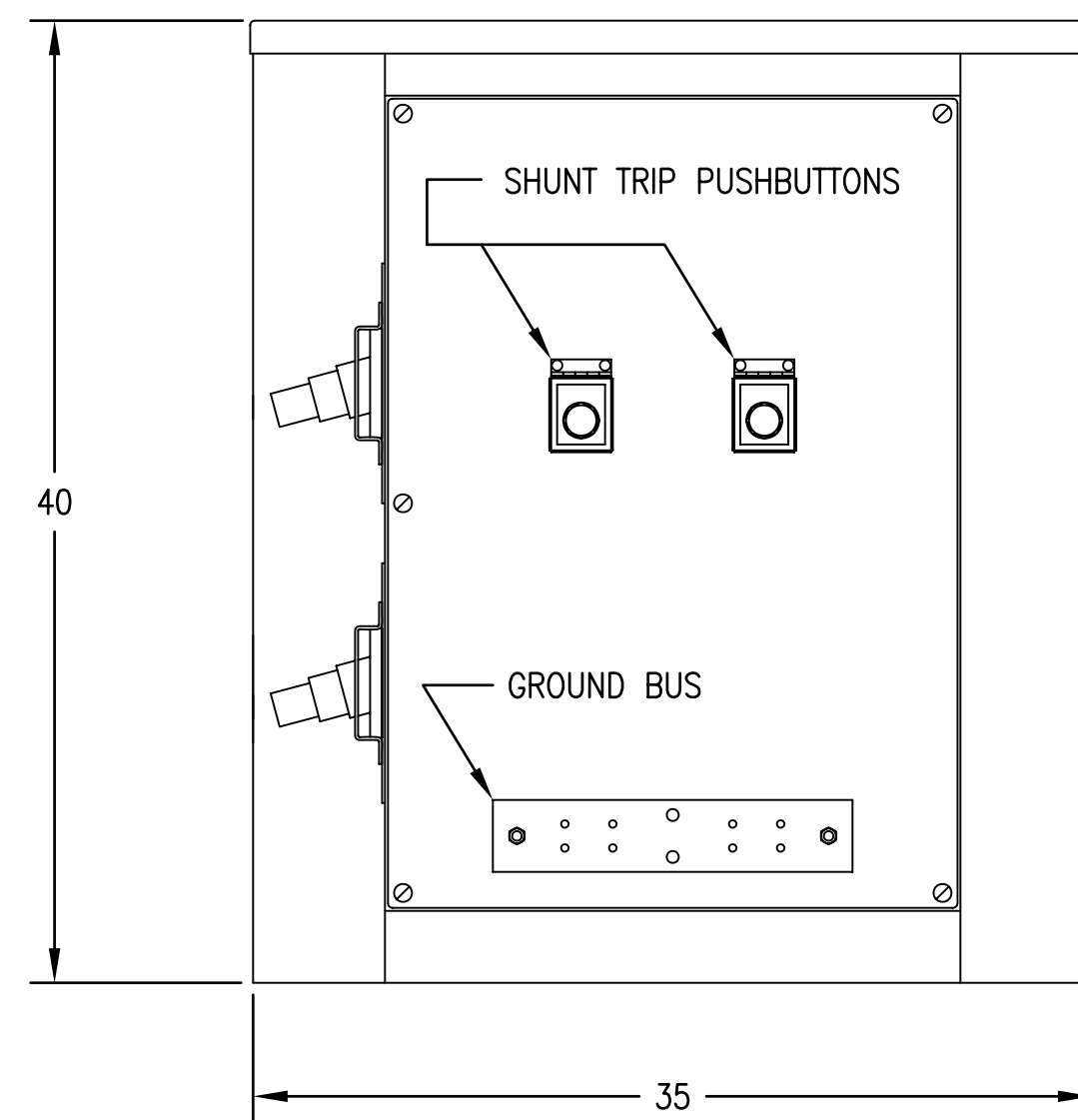

SIDE VIEW SHOWING EXTERNAL GROUND BUS AND SHUNT TRIP PUSHBUTTON ON RIGHT SIDE

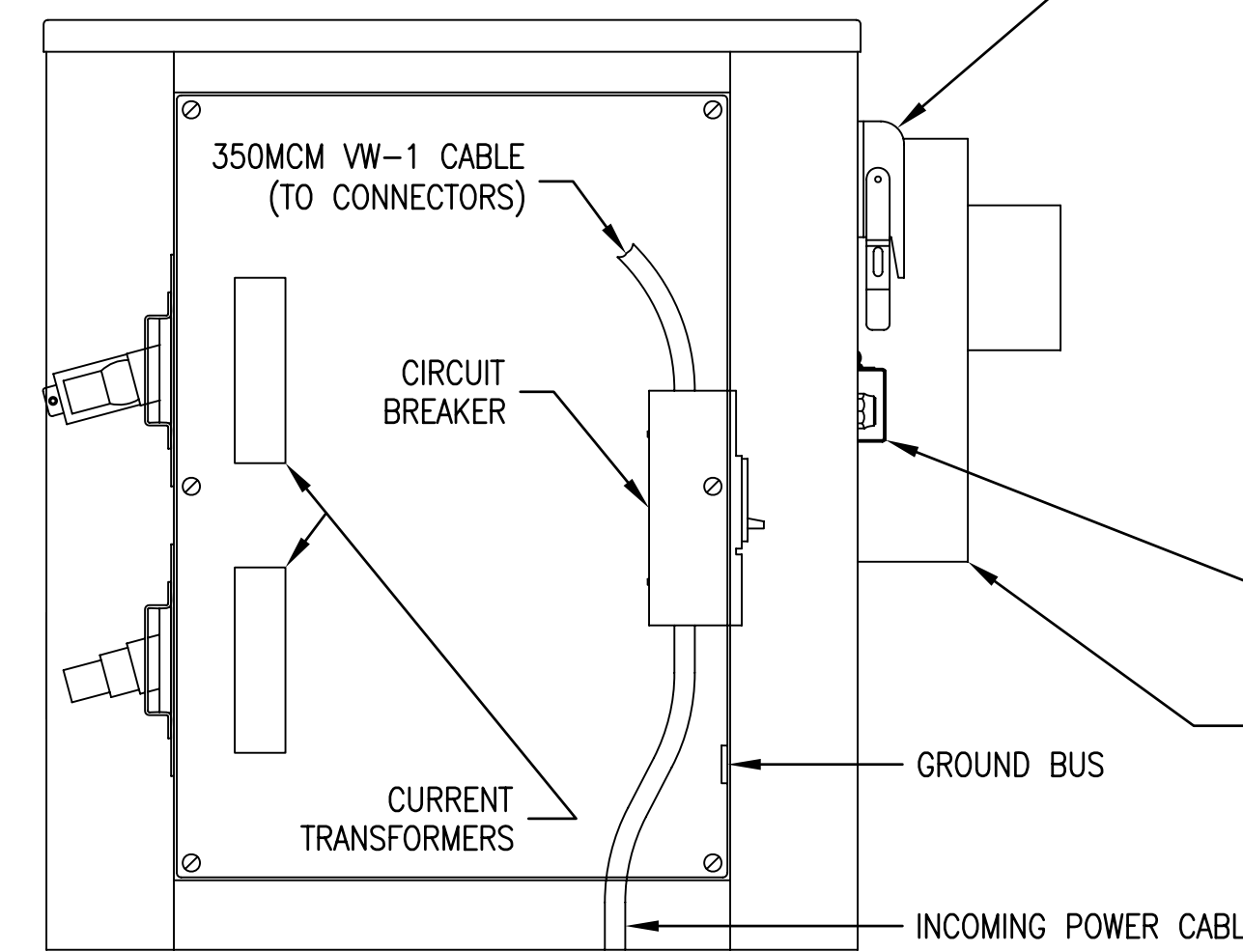

SIDE VIEW SHOWING INTERNAL CIRCUIT BREAKER AND METERING CURRENT TRANSFORMERS

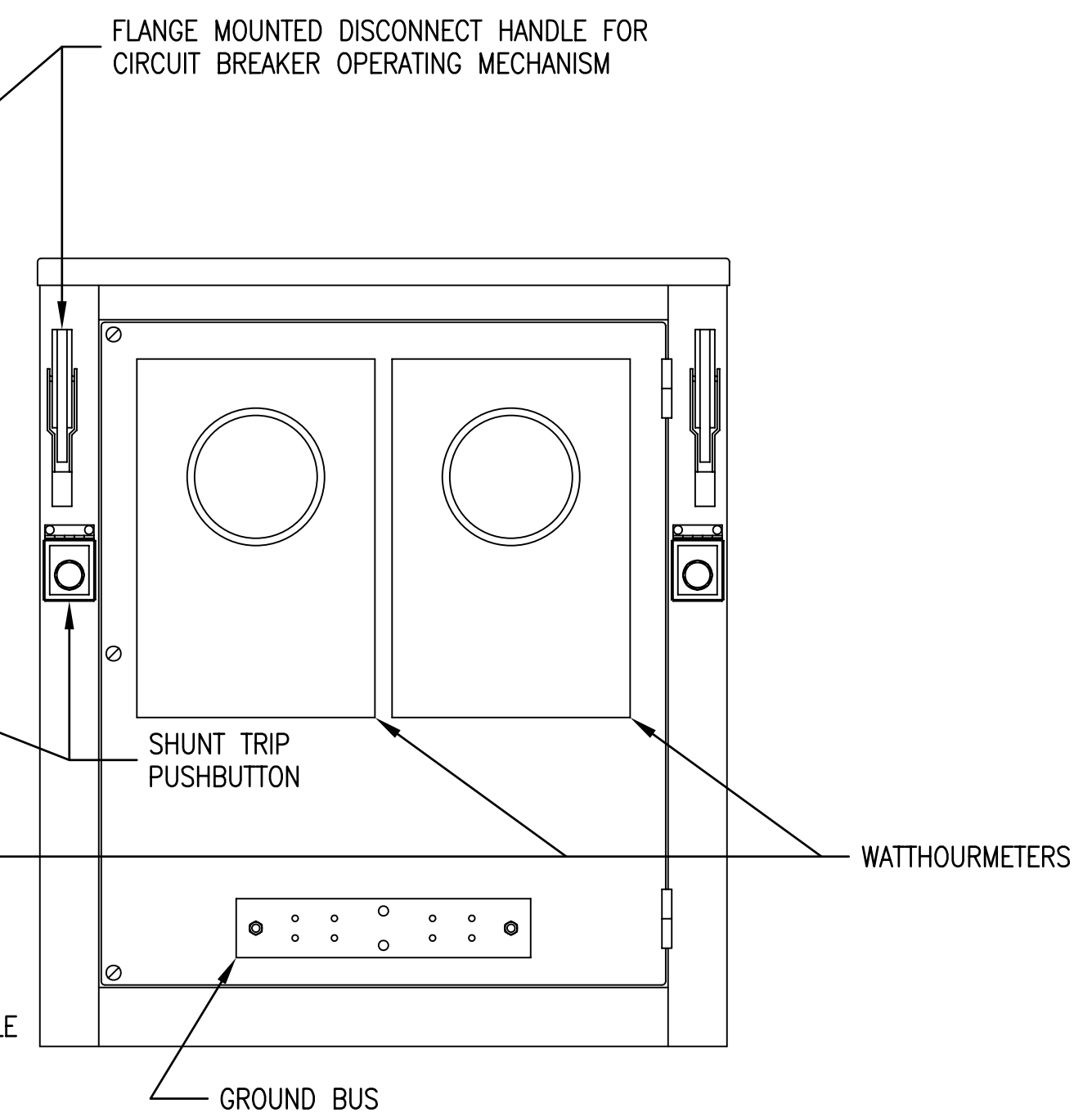

REAR VIEW SHOWING GROUND BUS AND SHUNT TRIP PUSHBUTTON ON REAR

26 05 33 - LAYOUT 2 (IP)
 600V INDUSTRIAL SERVICE POWER CONNECTION STATION

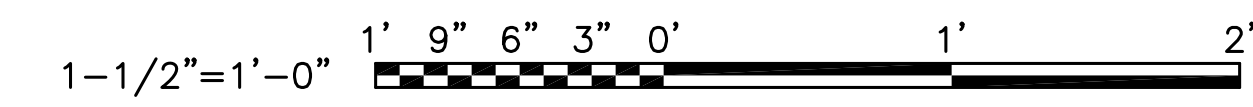

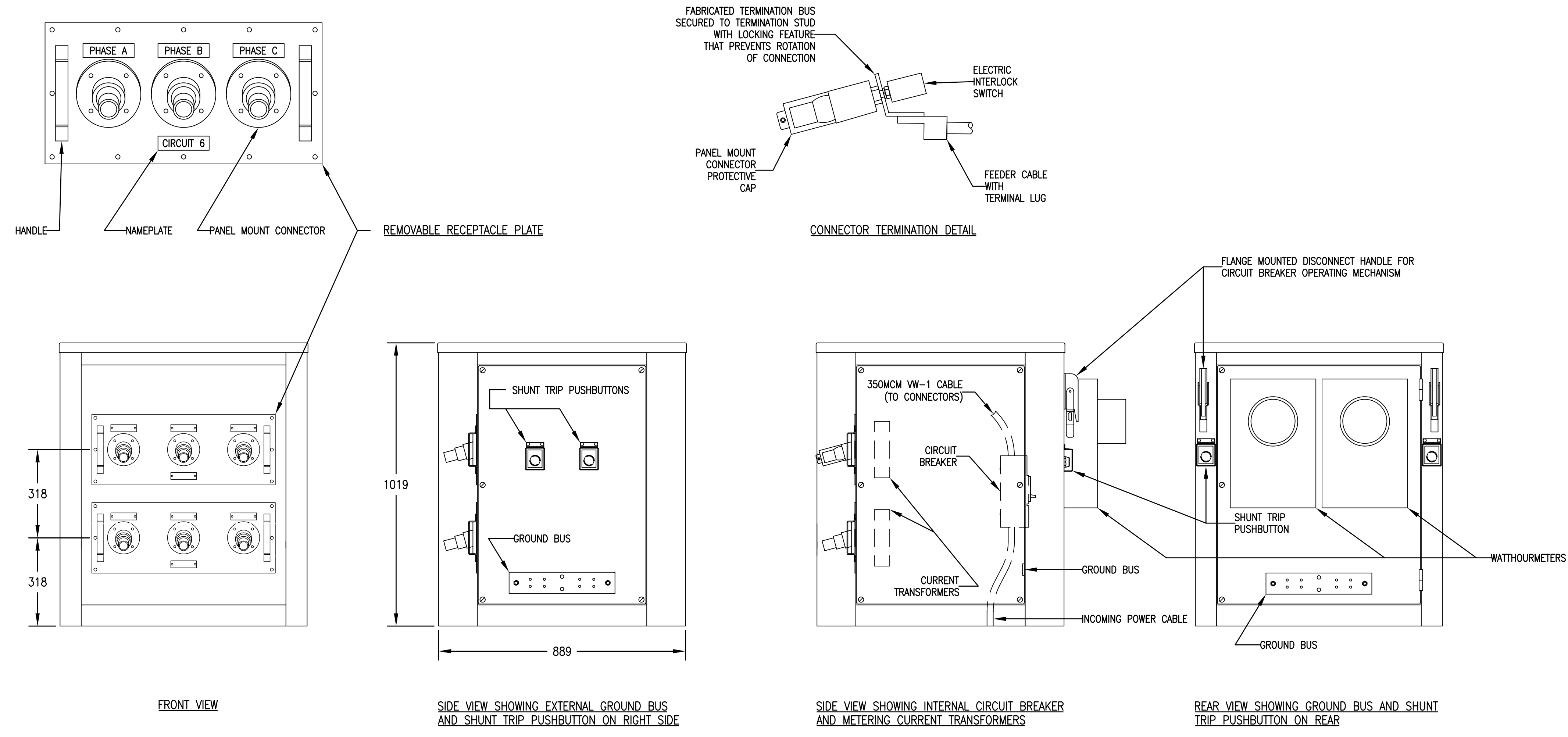

26 05 33 – LAYOUT 2 (SI)
 600V INDUSTRIAL SERVICE POWER CONNECTION STATION

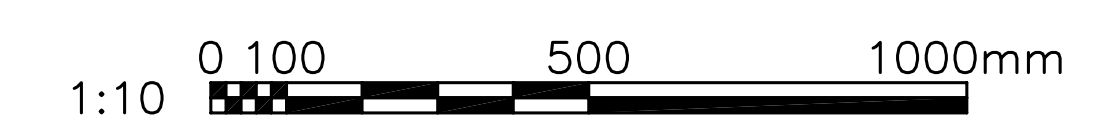

CONNECTION STATION COMPONENTS X

1. POWER RECEPTACLES SHALL BE 15KV EQUIPMENT MOUNT TYPE CABLE COUPLERS.
2. 600A, 15KV DEADBREAK JUNCTION CONFIGURED WITH 2 INTERFACES.
3. 600A INSULATED HIGH-VOLTAGE CONNECTORS.
4. 250KCMIL SINGLE CONDUCTOR FLEXIBLE POWER CABLE.
5. INCOMING POWER CABLE.

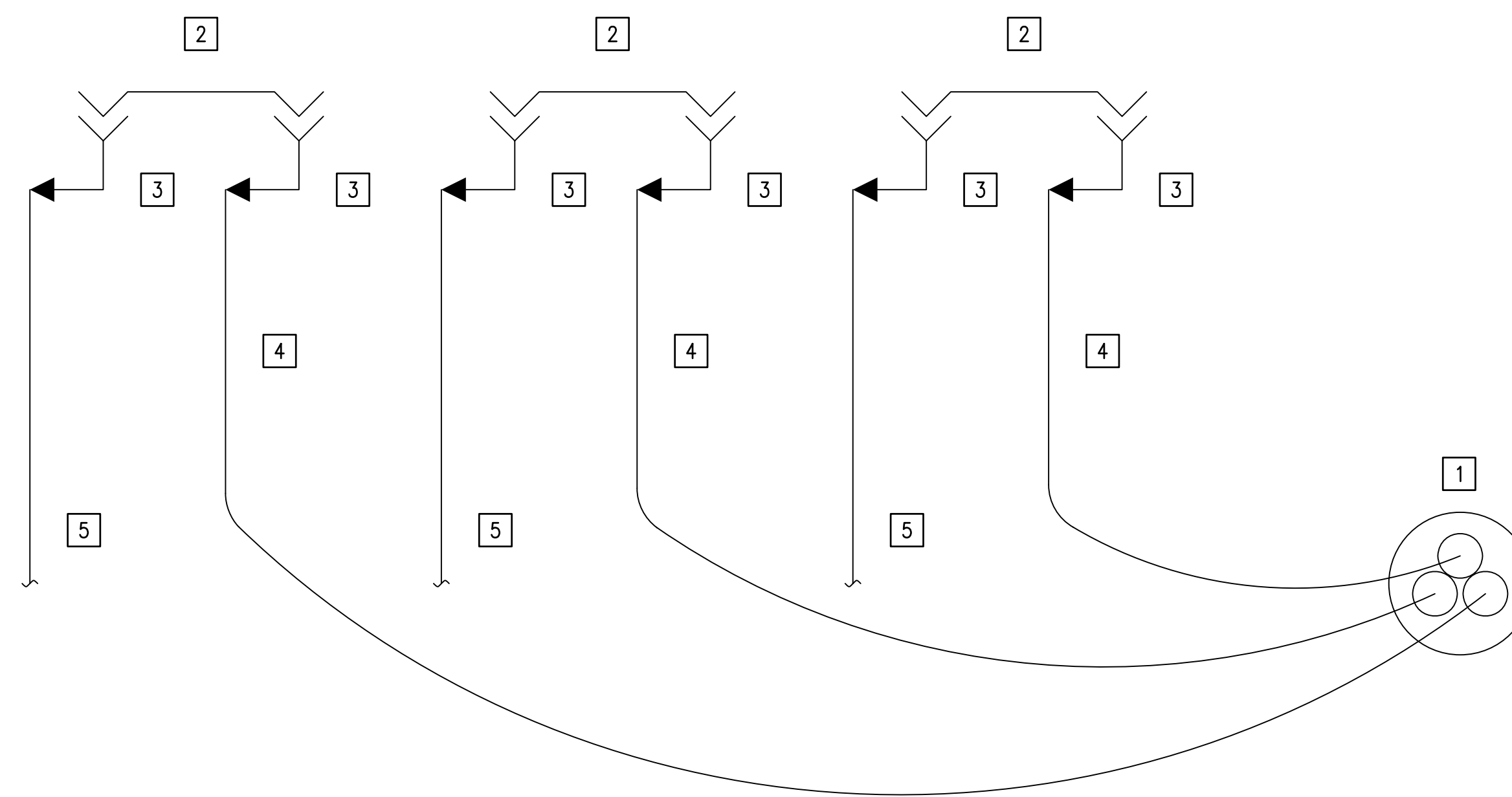

CONNECTION STATION DIAGRAM

TYPICAL FOR ONE OF FOUR RECEPTACLE CIRCUITS

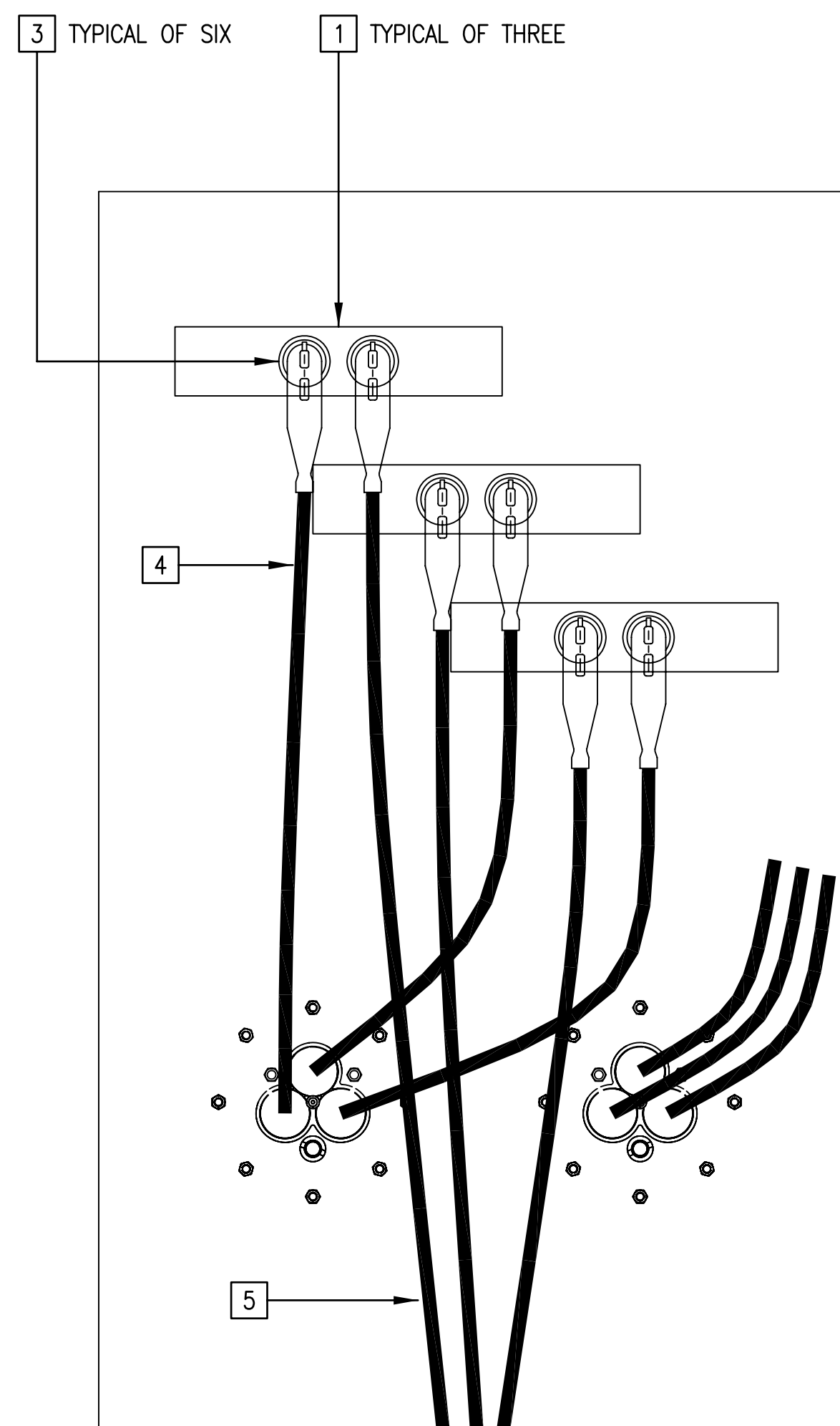

INSIDE LEFT SECTION VIEW

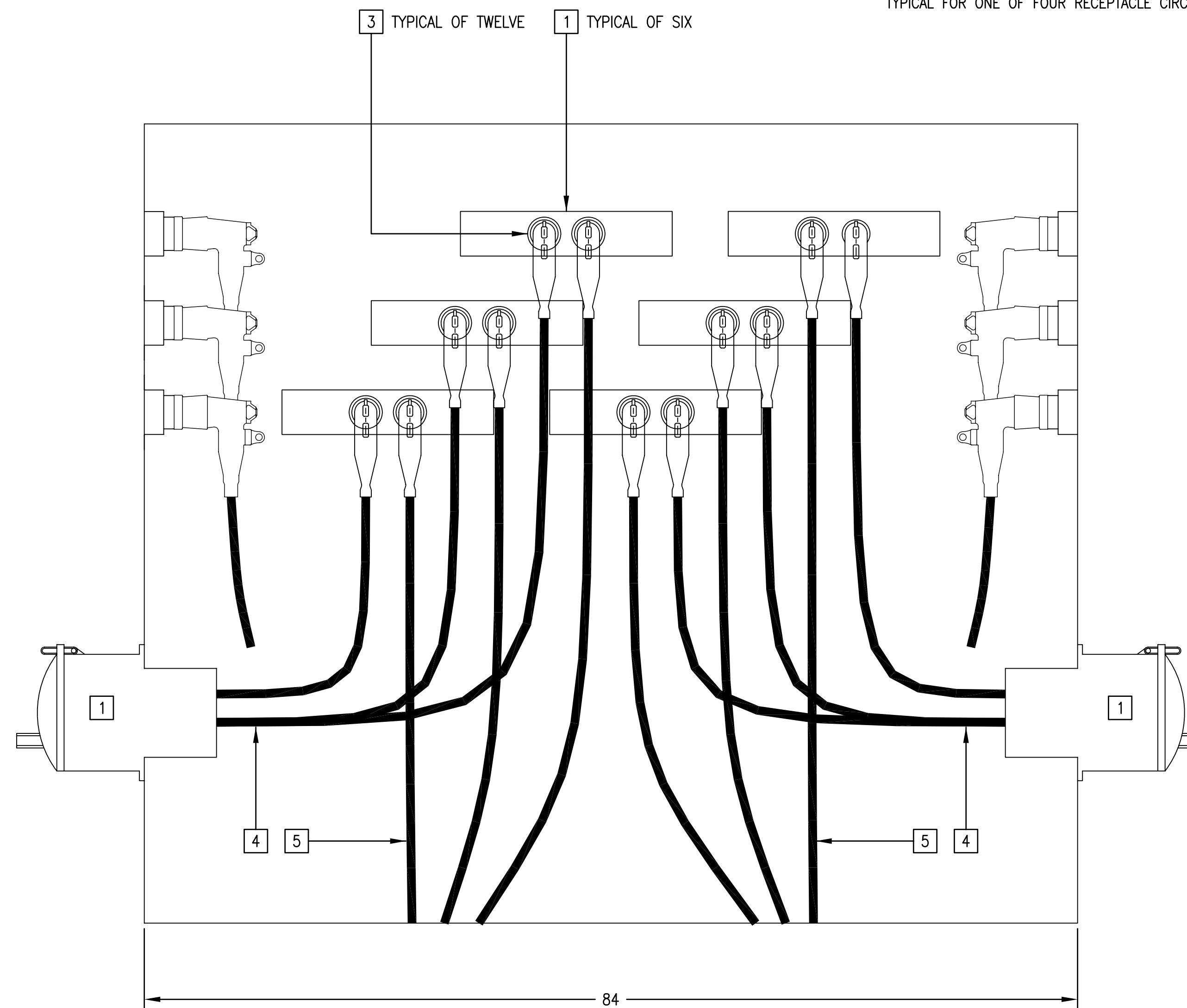

FRONT VIEW WITHOUT COVERS

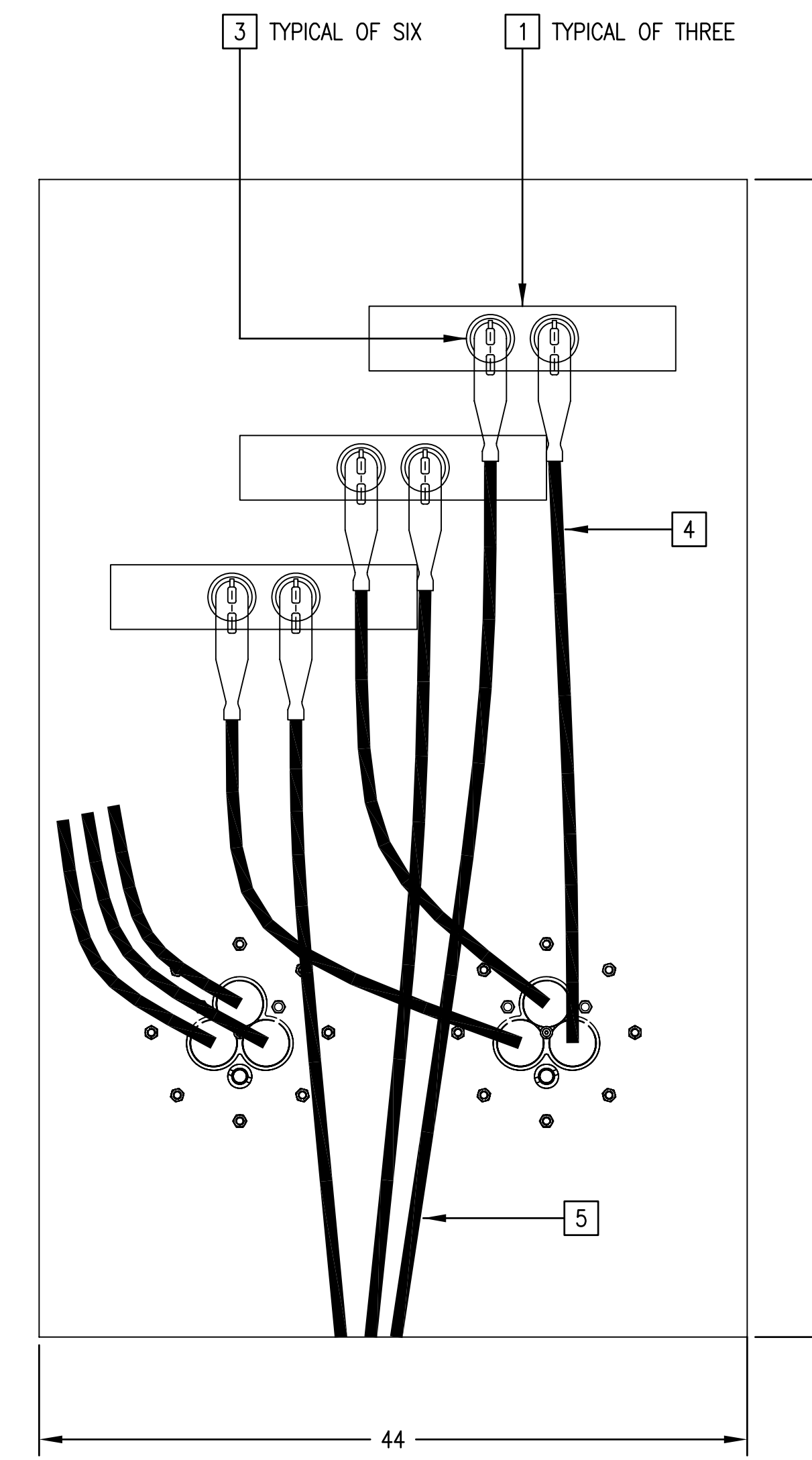

INSIDE RIGHT SECTION VIEW

26 05 33 - LAYOUT 3 (IP)
15KV POWER CONNECTION STATION

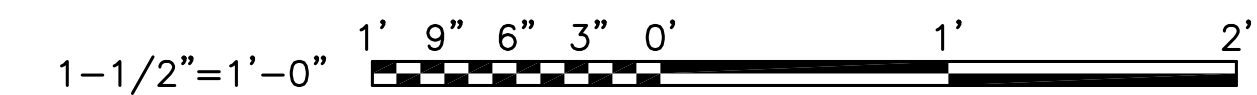

CONNECTION STATION COMPONENTS X

1. POWER RECEPTACLES SHALL BE 15KV EQUIPMENT MOUNT TYPE CABLE COUPLERS.
2. 600A, 15KV DEADBREAK JUNCTION CONFIGURED WITH 2 INTERFACES.
3. 600A INSULATED HIGH-VOLTAGE CONNECTORS.
4. 250KCMIL SINGLE CONDUCTOR FLEXIBLE POWER CABLE.
5. INCOMING POWER CABLE.

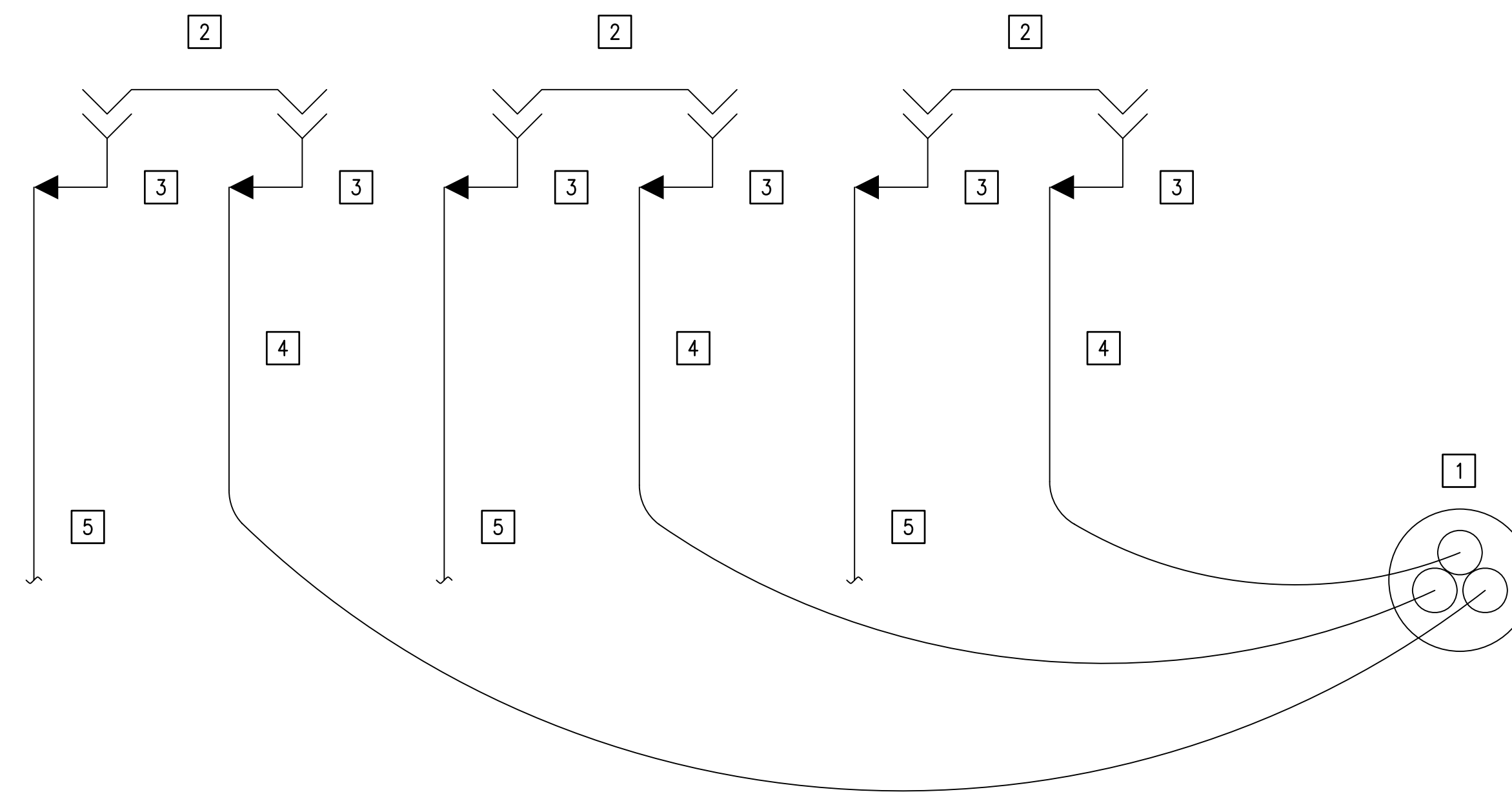

CONNECTION STATION DIAGRAM
TYPICAL FOR ONE OF FOUR RECEPTACLE CIRCUITS

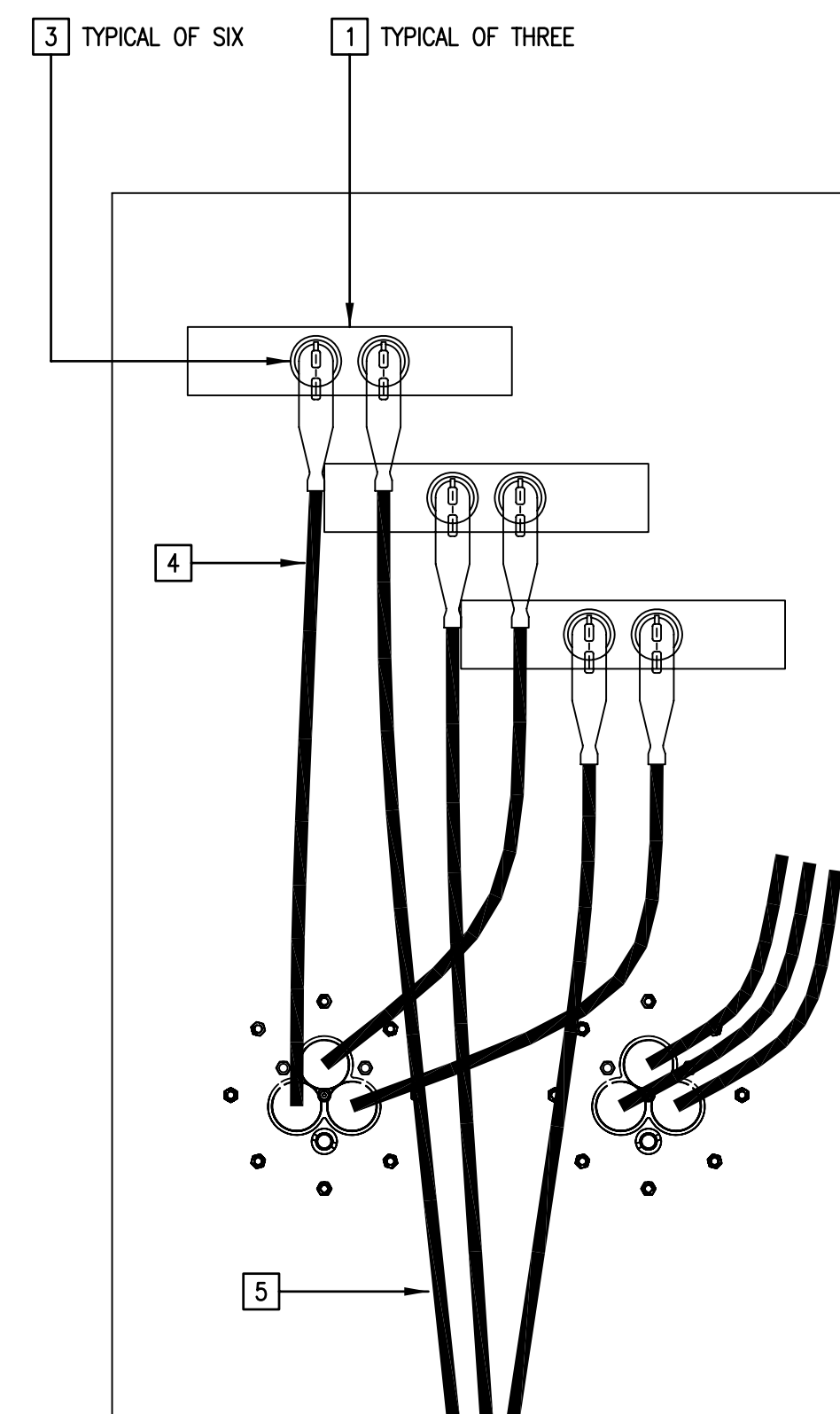

INSIDE LEFT SECTION VIEW

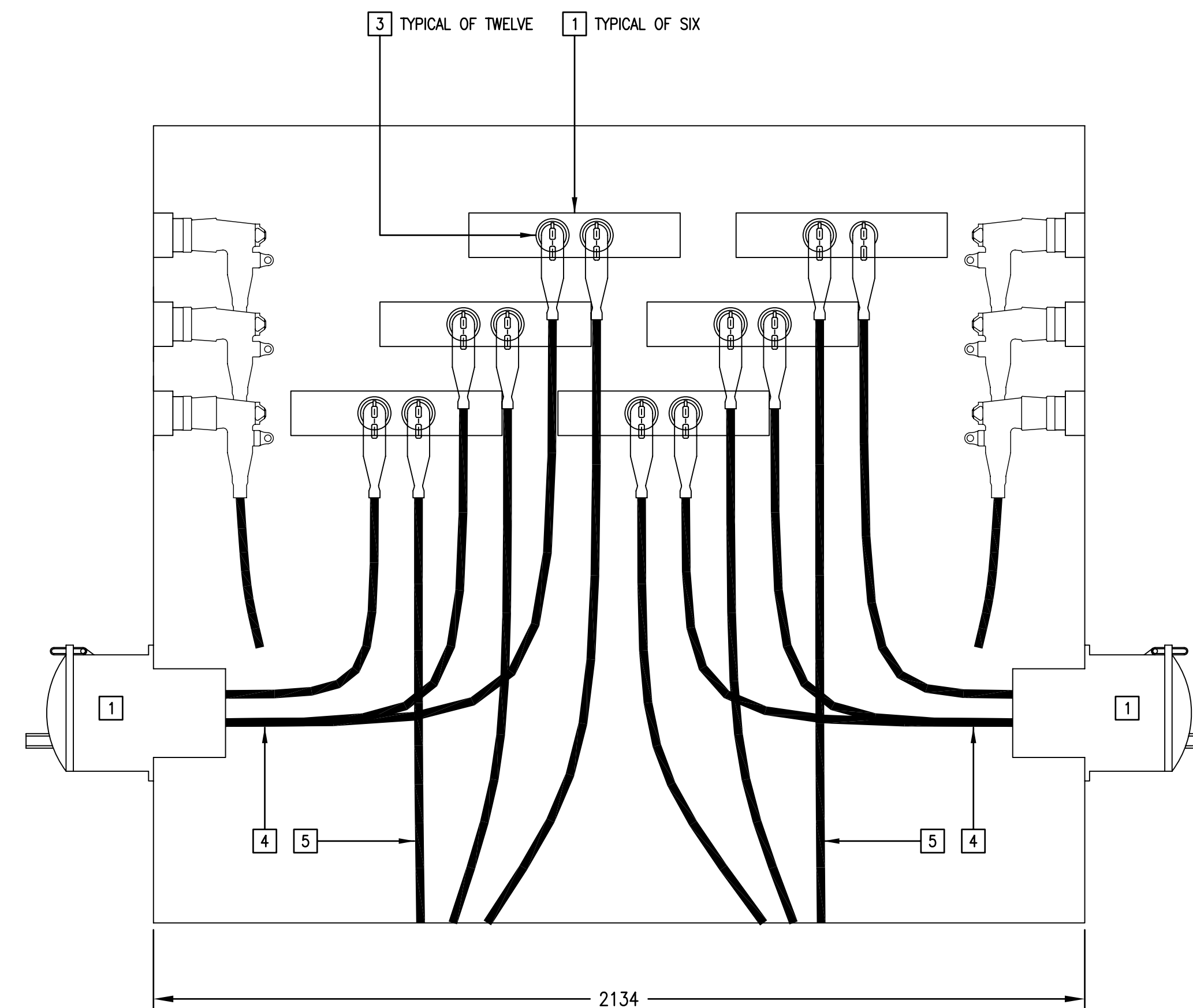

FRONT VIEW WITHOUT COVERS

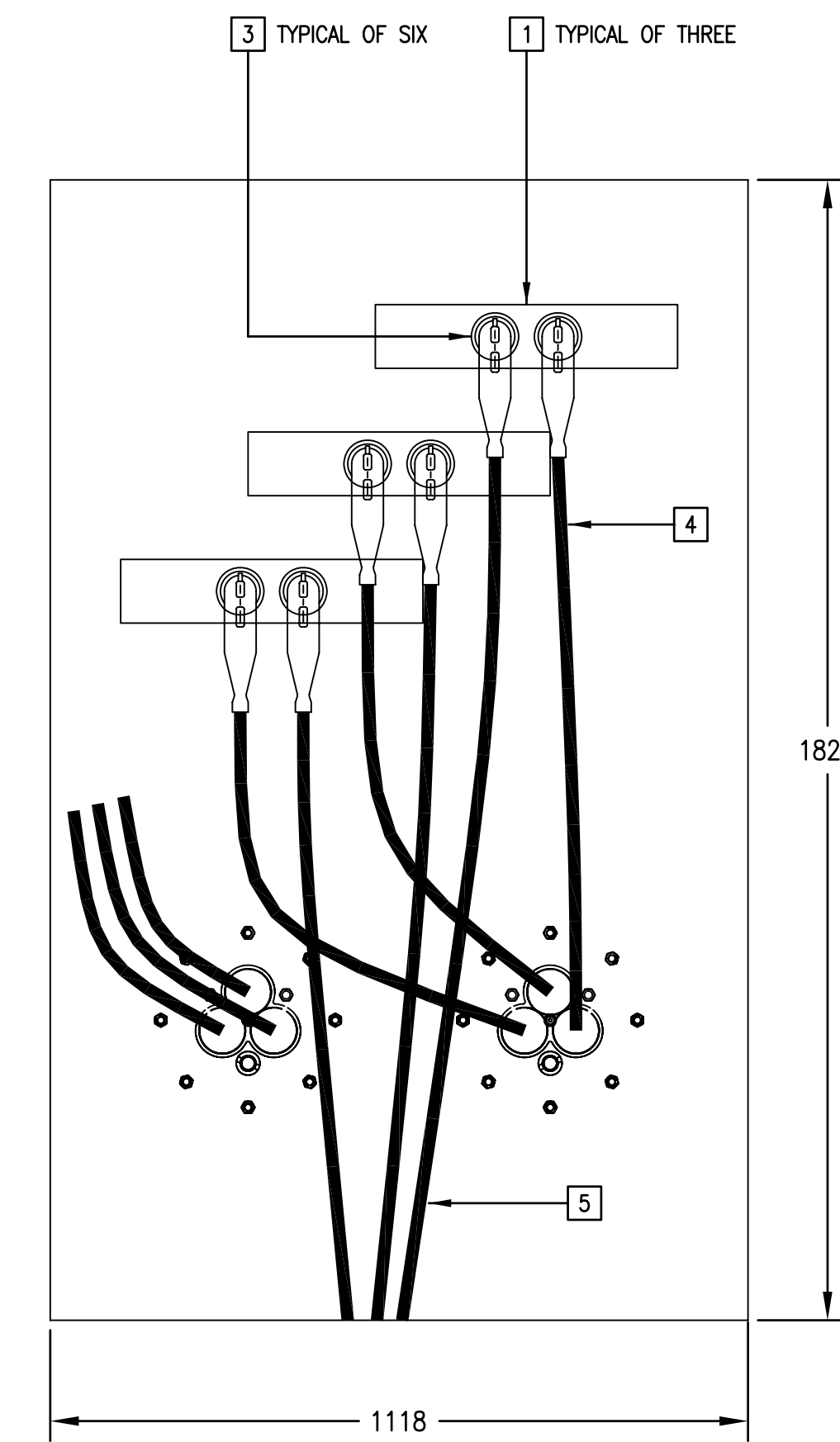

INSIDE RIGHT SECTION VIEW

26 05 33 - LAYOUT 3 (SI)
15KV POWER CONNECTION STATION

1:10 0 100 500 1000mm